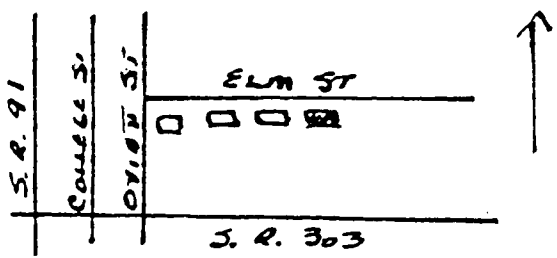

OHIO HISTORIC INVENTORY

Ohio Historic Preservation Office
Ohio Historical Center
Columbus, Ohio 43211

1. No.	4. Present Name(s) Residence, W. Atkinson
2. County Summit	5. Other Name(s)
3. Location of Negatives HHA 31-37	

6. Specific Location 120 Elm Street	16. Thematic Category D	28. No. of Stories 2
7. City or Town If Rural, Township & Vicinity Hudson	17. Date(s) or Period c. 1893	29. Basement? Yes <input checked="" type="checkbox"/> No <input type="checkbox"/>
8. Site Plan with North Arrow 	18. Style or Design not determined	30. Foundation Material structural tile
9. Coordinates Lat. _____ Long. _____ U.T.M. Reference 17 463646 4565475	19. Architect or Engineer	31. Wall Construction wood frame
10. Site <input type="checkbox"/> Building <input checked="" type="checkbox"/> Structure <input type="checkbox"/> Object <input type="checkbox"/>	20. Contractor or Builder	32. Roof Type & Material x-gable - tile
11. On National Register? Yes <input type="checkbox"/> No <input checked="" type="checkbox"/>	21. Original Use, if apparent residence	33. No. of Bays Front 5 Side 3
12. Is It Eligible? Yes <input checked="" type="checkbox"/> No <input type="checkbox"/>	22. Present Use residence	34. Wall Treatment beveled siding
13. Part of Estab. Hist. Dist.? Yes <input type="checkbox"/> No <input checked="" type="checkbox"/>	23. Ownership Public <input type="checkbox"/> Private <input checked="" type="checkbox"/>	35. Plan Shape Latin Cross
14. District Potent'l? Yes <input checked="" type="checkbox"/> No <input type="checkbox"/>	24. Owner's Name & Address, if known W. Atkinson 120 Elm Street Hudson 44236	36. Changes (Explain in #42) Addition <input type="checkbox"/> Altered <input type="checkbox"/> Moved <input type="checkbox"/>
15. Name of Established District	25. Open to Public? Yes <input type="checkbox"/> No <input checked="" type="checkbox"/>	37. Condition Interior _____ Exterior good
16. Further Description of Important Features Decorative verge board at front gable; lattice work and decorative roof trim on glassed-in porch at entrance, northwest corner; one-story wing to east; one and one-half story wing to west, with small windows to roof line.	26. Local Contact Person or Organization Hudson Heritage Association	38. Preservation Underway? Yes <input checked="" type="checkbox"/> No <input type="checkbox"/>
17. History and Significance	27. Other Surveys in Which Included	39. Endangered? By What? Yes <input type="checkbox"/> No <input checked="" type="checkbox"/>
18. Description of Environment and Outbuildings Detached garage. Quiet residential street in area of public high school; very little traffic.	28. Prepared by L Newkirk, F Barlow	40. Visible from Public Road? Yes <input checked="" type="checkbox"/> No <input type="checkbox"/>
19. Sources of Information Summit County Tax Assessment records Personal inspection	29. Organization HHA	41. Distance from and Frontage on Road
	30. Date	31. Revision Date(s)

Summit
Residence, W. Atkinson

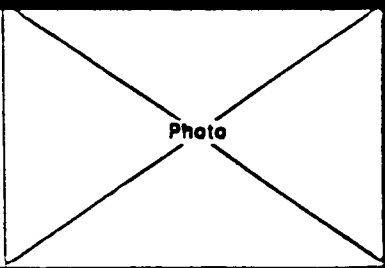



dba: RENEWAL BY ANDERSEN OF CLEVELAND

Legal Name: Renewal by Andersen LLC | License # (null)
17450 Engle Lake Drive, Suite 108 | Middleburg Heights , OH 44130
Phone: 216-503-6200 | Fax: 216-573-1438 |
rbaclevelandorders@andersencorp.com
Measure Tech: Santino Owen, (330)807-5693

David Dunne

120 Elm St
Hudson, OH 44236
H: (330)554-0531
C: (330)245-6356

Installation Package

120 Elm St

Hudson, OH 44236

PRODUCTS: 6 WINDOWS: 5 PATIO DOORS: 0 ENTRY DOORS: 0 SPECIALTY: 0 MISC: 1
Updated 2/27/24

BUYER

David Dunne

120 Elm St
Hudson, OH 44236
H: (330)554-0531
C: (330)245-6356
Year Built: 1893
mrddunne@gmail.com
Est. Duration:

REPRESENTATIVE

Andrew Gursky

(330)417-5014
andrew.gursky@rba-
clevelandregion.com

TECH MEASURE

Santino Owen

(330)807-5693
santino.owen@andersencorp.com

dba: RENEWAL BY ANDERSEN OF CLEVELAND

Legal Name: Renewal by Andersen LLC | License # (null)
17450 Engle Lake Drive, Suite 108 | Middleburg Heights , OH 44130
Phone: 216-503-6200 | Fax: 216-573-1438 |
rbaclevelandorders@andersencorp.com
Measure Tech: Santino Owen, (330)807-5693



Order Summary

dba: RENEWAL BY ANDERSEN OF CLEVELAND

Legal Name: Renewal by Andersen LLC | License # (null)
 17450 Engle Lake Drive, Suite 108 | Middleburg Heights, OH 44130
 Phone: 216-503-6200 | Fax: 216-573-1438 |
 rbaclevelandorders@andersencorp.com
 Measure Tech: Santino Owen, (330)807-5693

David Dunne
 120 Elm St
 Hudson, OH 44236
 H: (330)554-0531
 C: (330)245-6356

ID#	ROOM	SIZE	DETAILS
-----	------	------	---------

JOB

201	maggies room	28" 28-1/2"	61" 61-3/4"	<p>Window: Acclaim™ Double-Hung (DG), 1:1, Slope Sill, Insert Frame, Traditional Checkrail, Exterior White, Interior White Performance Calculator: PG Rating: 40 DP Rating: + 40 / - 40 Glass: All Sash: High Performance SmartSun Glass, No Pattern Hardware: White Screen: Fiberglass, Full Screen Grille Style: No Grille Misc: Wood Insert Small Cap - , RBA Cleveland will remove existing wood window sashes to set the new window into the existing wood frame. This type of installation will typically result in a loss of glass area. A new interior stop may be required and will be provided by RBA Cleveland in an unfinished pine that will be the homeowners responsibility to paint or stain. On the exterior RBA Cleveland will finish the new window with color matched aluminum coil to marry back to existing wood window frame as minimal as possible.</p> <p>Make this a db***** Construction: 2nd Floor install (1), LSWP Per opening (1), R & R Shutter (1) Material: 1 3/8" Modern Stop - 10ft (2), Caulk -White Interior (0.25), Coil - White (1), Caulk -White Exterior (2.5) Sill Angle: FS°</p>
202	Primary Bedroom	58" 59"	38" 40"	<p>Window: Acclaim™ Casement Triple, 1:1:1, Left Vent / Stat / Right Vent, Base Frame, Exterior White, Interior White Performance Calculator: PG Rating: 40 DP Rating: + 40 / - 40 Glass: All Sash: High Performance SmartSun Glass, No Pattern Hardware: White Screen: Aluminum, Full Screen Grille Style: Grilles Between Glass (GBG) Grille Pattern: All Sash: Colonial 2w x 3h Misc: Wood Full Frame Capping - Pine, RBA Cleveland will remove existing wood window, all interior trim, and any needed exterior trim to bring the opening back to the framing of the house.</p>



Order Summary

dba: RENEWAL BY ANDERSEN OF CLEVELAND

Legal Name: Renewal by Andersen LLC | License # (null)
 17450 Engle Lake Drive, Suite 108 | Middleburg Heights , OH 44130
 Phone: 216-503-6200 | Fax: 216-573-1438 |
 rbaclevelandorders@andersencorp.com
 Measure Tech: Santino Owen, (330)807-5693

David Dunne
 120 Elm St
 Hudson, OH 44236
 H: (330)554-0531
 C: (330)245-6356

ID#	ROOM	SIZE	DETAILS
			<p>The new window will be installed inside of the rough opening and color matched coil will be used to cap back to the existing exterior siding. On the interior a new interior wood trim kit in unfinished pine will be installed.</p> <p>ENTER MOULDING SIZE & STYLE: Construction: 2nd Floor install (1), Insert as Full Frame (1), LSWP Per opening (1), Build Trim Kit on Site (1), Stool and Apron (1), Steel Pan (1) Material: *Casing Innovations 350-91 in 3" wide Poplar - 10Ft* (4), 1x4 S4S - 8ft (2), Stool 3 1/2" STD Bevel (5/4 x 4) 8ft (1), 1x4x8ft #2 Pine (2), Coil - White (0.15), Caulk -White Exterior (3), Caulk -White Interior (0.25)</p>
203	Primary Bedroom	38" 39"	38" 40"
			<p>Window: Acclaim™ Casement Double, Vented, Base Frame, Exterior White, Interior White Performance Calculator: PG Rating: 40 DP Rating: + 40 / - 40 Glass: All Sash: High Performance SmartSun Glass, No Pattern Hardware: White Screen: Aluminum, Full Screen Grille Style: Grilles Between Glass (GBG) Grille Pattern: All Sash: Colonial 2w x 3h Misc: Wood Full Frame Capping - Pine, RBA Cleveland will remove existing wood window, all interior trim, and any needed exterior trim to bring the opening back to the framing of the house. The new window will be installed inside of the rough opening and color matched coil will be used to cap back to the existing exterior siding. On the interior a new interior wood trim kit in unfinished pine will be installed.</p> <p>ENTER MOULDING SIZE & STYLE: Construction: 2nd Floor install (1), Insert as Full Frame (1), LSWP Per opening (1), Build Trim Kit on Site (1), Stool and Apron (1), Steel Pan</p>



Order Summary

dba: RENEWAL BY ANDERSEN OF CLEVELAND

Legal Name: Renewal by Andersen LLC | License # (null)
 17450 Engle Lake Drive, Suite 108 | Middleburg Heights, OH 44130
 Phone: 216-503-6200 | Fax: 216-573-1438 |
 rbaclevelandorders@andersencorp.com
 Measure Tech: Santino Owen, (330)807-5693

David Dunne
 120 Elm St
 Hudson, OH 44236
 H: (330)554-0531
 C: (330)245-6356

ID#	ROOM	SIZE	DETAILS
-----	------	------	---------

(1) **Material:** *Casing Innovations 350-91 in 3" wide Poplar - 10Ft* (4), 1x4 S4S - 8ft (2), Stool 3 1/2" STD Bevel (5/4 x 4) 8ft (1), 1x4x8ft #2 Pine (2), Coil - White (0.15), Caulk -White Exterior (2), Caulk -White Interior (0.25)

204	Primary Bedroom	54" 55"	62" 64"	<p>Window: Acclaim™ Casement Double, Vented, Base Frame, Exterior White, Interior White Performance Calculator: PG Rating: 35 DP Rating: + 35 / - 35 Glass: All Sash: High Performance SmartSun Glass, No Pattern Hardware: White Screen: Aluminum, Full Screen Grille Style: Grilles Between Glass (GBG) Grille Pattern: All Sash: Colonial 2w x 5h Misc: Wood Full Frame Capping - Pine, RBA Cleveland will remove existing wood window, all interior trim, and any needed exterior trim to bring the opening back to the framing of the house. The new window will be installed inside of the rough opening and color matched coil will be used to cap back to the existing exterior siding. On the interior a new interior wood trim kit in unfinished pine will be installed.</p> <p>ENTER MOULDING SIZE & STYLE: Construction: 2nd Floor install (1), Insert as Full Frame (1), LSWP Per opening (1), Build Trim Kit on Site (1), Stool and Apron (1), Steel Pan (1) Material: *Casing Innovations 350-91 in 3" wide Poplar - 10Ft* (4), 1x4 S4S - 8ft (4), Stool 3 1/2" STD Bevel (5/4 x 4) 8ft (1), 1x4x8ft #2 Pine (2), Coil - White (0.15), Caulk -White Exterior (2), Caulk -White Interior (0.25)</p>
-----	-----------------	------------	------------	---

205	Primary Bedroom	38" 39"	39" 40"	<p>Window: Acclaim™ Casement Double, Vented, Base Frame, Exterior White, Interior White Performance Calculator: PG Rating: 40 DP Rating: + 40 / - 40 Glass: All Sash: High Performance SmartSun</p>
-----	-----------------	------------	------------	--



Order Summary

dba: RENEWAL BY ANDERSEN OF CLEVELAND

Legal Name: Renewal by Andersen LLC | License # (null)
 17450 Engle Lake Drive, Suite 108 | Middleburg Heights, OH 44130
 Phone: 216-503-6200 | Fax: 216-573-1438 |
 rbaclevelandorders@andersencorp.com
 Measure Tech: Santino Owen, (330)807-5693

David Dunne
 120 Elm St
 Hudson, OH 44236
 H: (330)554-0531
 C: (330)245-6356

ID#	ROOM	SIZE	DETAILS
			<p>Glass, No Pattern Hardware: White Screen: Aluminum, Full Screen Grille Style: Grilles Between Glass (GBG) Grille Pattern: All Sash: Colonial 2w x 3h Misc: Wood Full Frame Capping - Pine, RBA Cleveland will remove existing wood window, all interior trim, and any needed exterior trim to bring the opening back to the framing of the house. The new window will be installed inside of the rough opening and color matched coil will be used to cap back to the existing exterior siding. On the interior a new interior wood trim kit in unfinished pine will be installed.</p> <p>ENTER MOULDING SIZE & STYLE: Construction: 2nd Floor install (1), Insert as Full Frame (1), LSWP Per opening (1), Build Trim Kit on Site (1), Stool and Apron (1), Steel Pan (1) Material: *Casing Innovations 350-91 in 3" wide Poplar - 10Ft* (4), 1x4 S4S - 8ft (2), Stool 3 1/2" STD Bevel (5/4 x 4) 8ft (1), 1x4x8ft #2 Pine (2), Coil - White (0.15), Caulk -White Exterior (2), Caulk -White Interior (0.25)</p>
201	Maggie's room	0" 0"	<p>Misc: Misc, Customer Casing/Trim, Notes, Quantity 1, Db to match the others Construction: None Material: None</p>

PRODUCTS: 6 WINDOWS: 5 PATIO DOORS: 0 ENTRY DOORS: 0 SPECIALTY: 0 MISC: 1

Updated 2/27/24

JOB NOTES

4 pella pan full frames & 1 DB* double hung as an insert (to match previous install).

The 4 pella pan full frame removals are all casements matching like for like. Special order 3" poplar casing ordered - stool & apron style trim kits. Customer plans to paint post install, sending interior caulk. Aprons were slightly different sizes, some having extra pieces added - use interior caulk were needed around new.

Opening 201 is a DB style double hung getting inserted into existing rope and weight style frame. Shim up under each corner with heavy back-caulk under sill. Leave in locked position after set. Sending 1-3/8" OG stops incase existing get damaged during tear out.

Match all capping like for like from previous install - traditional style full caps

Estimated Duration:



Order Summary

dba: RENEWAL BY ANDERSEN OF CLEVELAND

Legal Name: Renewal by Andersen LLC | License # (null)
 17450 Engle Lake Drive, Suite 108 | Middleburg Heights, OH 44130
 Phone: 216-503-6200 | Fax: 216-573-1438 |
 rbaclevelandorders@andersencorp.com
 Measure Tech: Santino Owen, (330)807-5693

David Dunne
 120 Elm St
 Hudson, OH 44236
 H: (330)554-0531
 C: (330)245-6356

FLOORPLAN - 1ST FLOOR

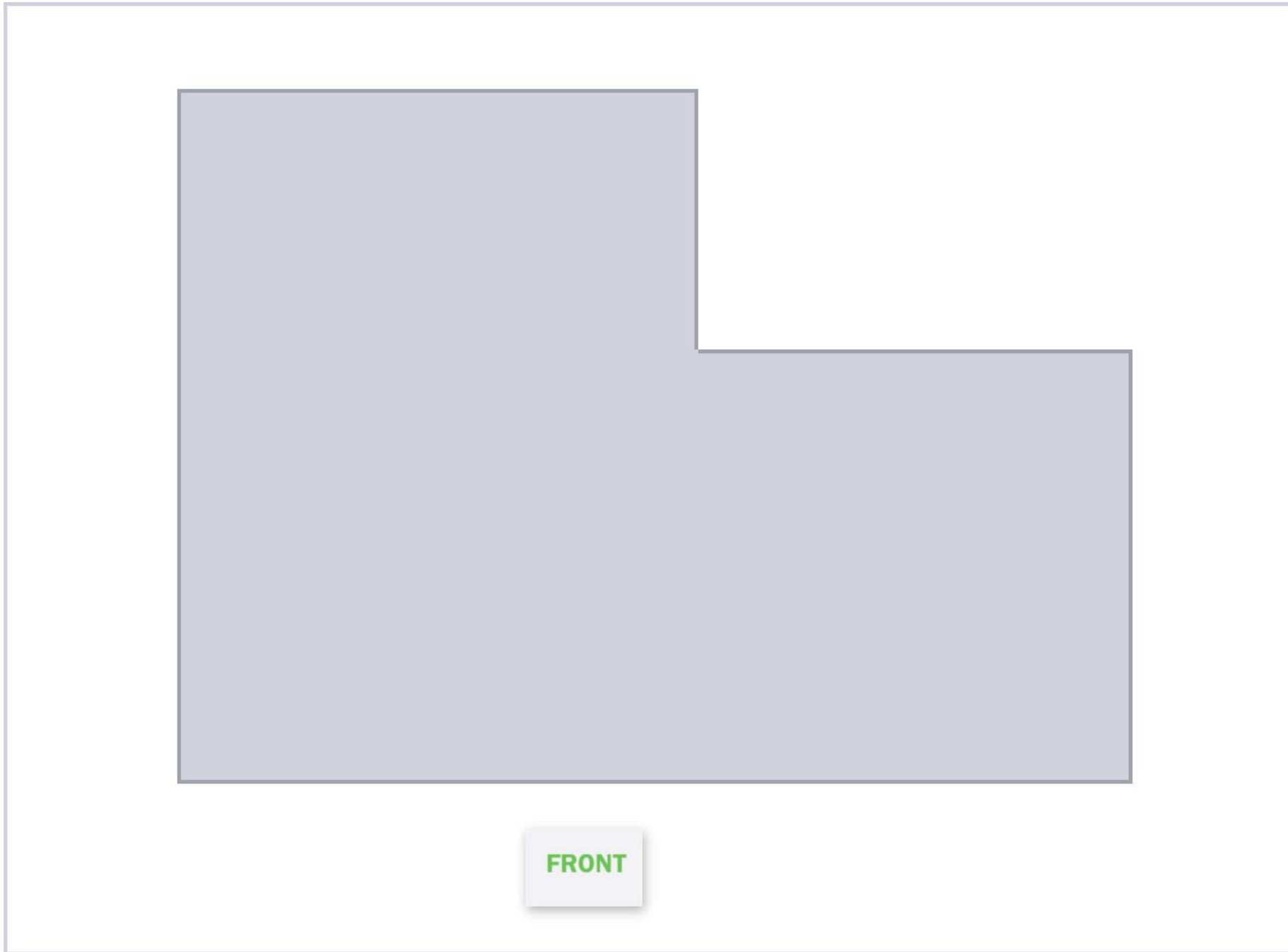

UNIT NOTES

- 201** DB, SHIM UP, extra back-caulk
Keep locked
- 201** Db to match the others
- 202** Exterior sash - sash is 59w by 40h
Pl-pl 63-3/4light by 45-3/4
- 203** Exterior sash - sash is 39w by 40h
Pl-pl 43-3/4w by 46h
- 204** Exterior Sash-sash 55w by 64h
Pl-pl 59-3/4w x 69-3/4h
- 205** Exterior sash - sash is 39w by 40h
Pl-pl 43-5/8w by 46-5/8h

FLOORPLAN - 2ND FLOOR

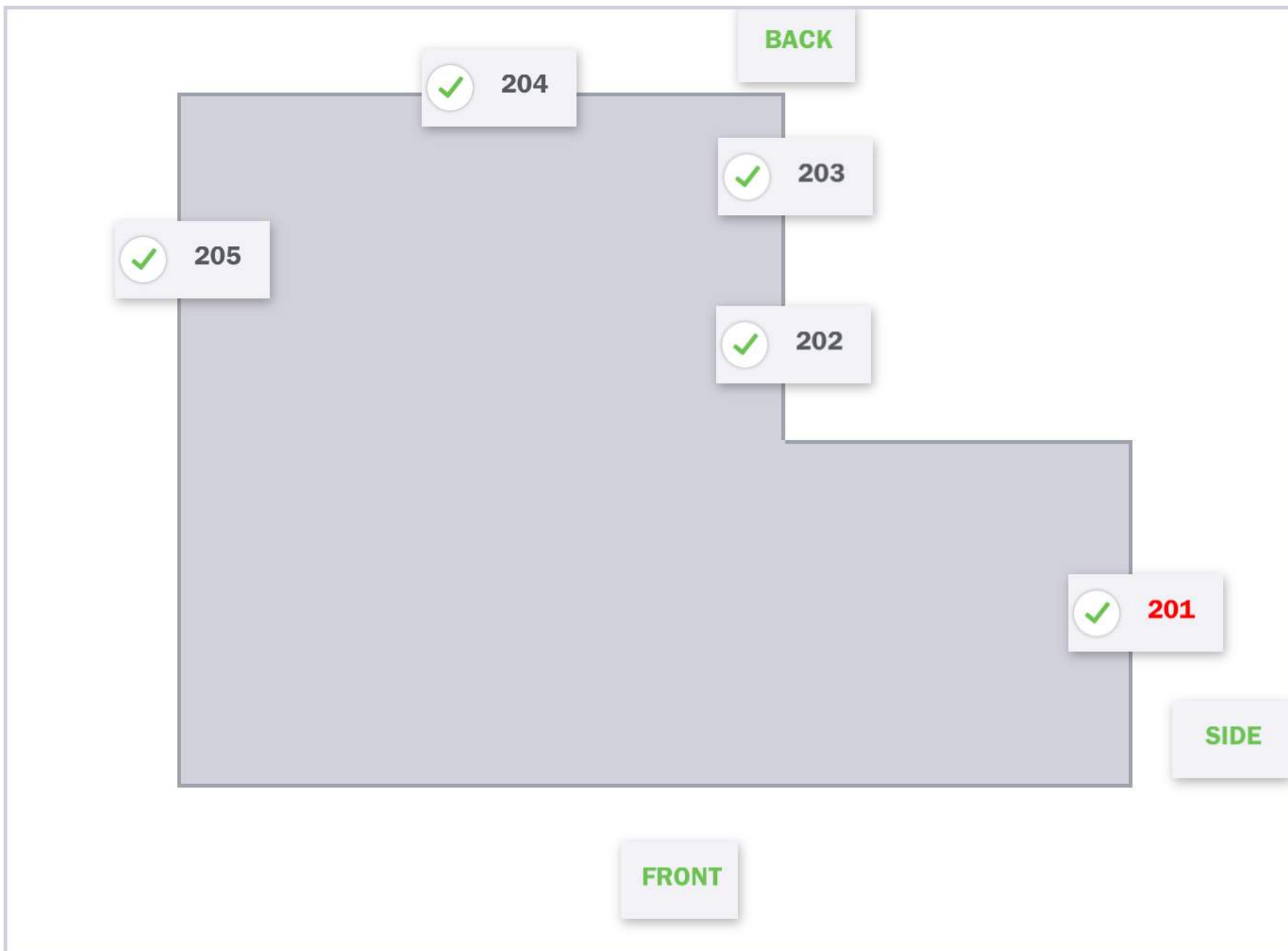

UNIT NOTES



Order Summary

dba: RENEWAL BY ANDERSEN OF CLEVELAND

Legal Name: Renewal by Andersen LLC | License # (null)
 17450 Engle Lake Drive, Suite 108 | Middleburg Heights, OH 44130
 Phone: 216-503-6200 | Fax: 216-573-1438 |
 rbaclevelandorders@andersencorp.com
 Measure Tech: Santino Owen, (330)807-5693

David Dunne
 120 Elm St
 Hudson, OH 44236
 H: (330)554-0531
 C: (330)245-6356

JOB PHOTOS



Image 1



Image 2



Image 3



Image 4



Image 7



Image 8

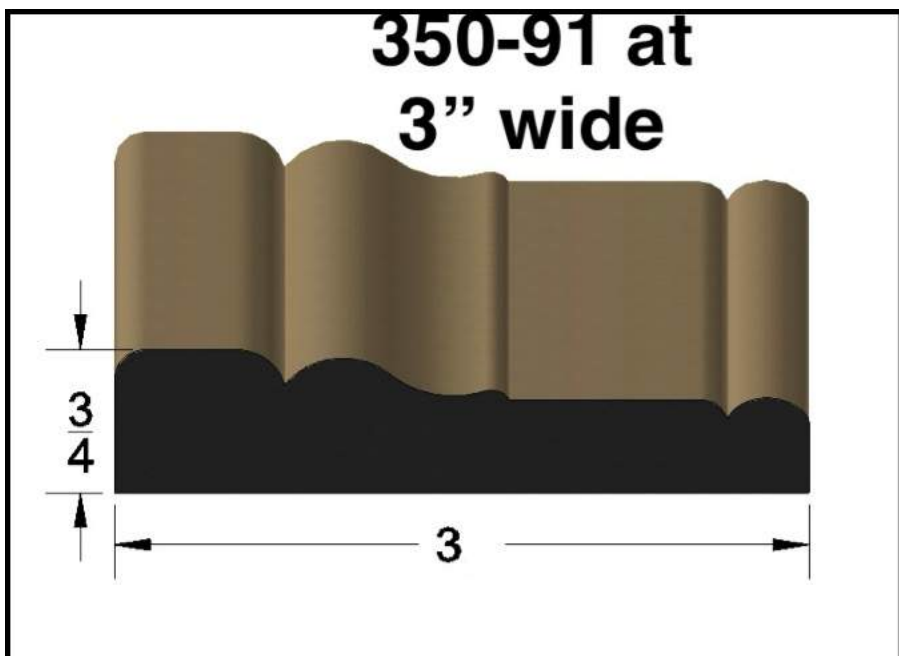

Image 5

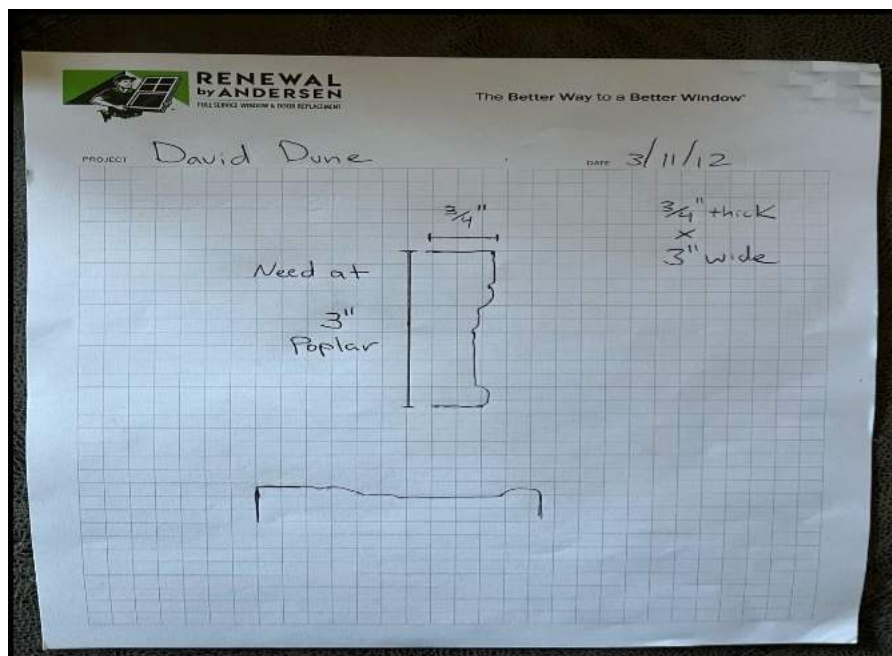

Image 6



201

dba: RENEWAL BY ANDERSEN OF CLEVELAND

Legal Name: Renewal by Andersen LLC | License # (null)
 17450 Engle Lake Drive, Suite 108 | Middleburg Heights, OH 44130
 Phone: 216-503-6200 | Fax: 216-573-1438 |
 rbaclevelandorders@andersencorp.com
 Measure Tech: Santino Owen, (330)807-5693

David Dunne
 120 Elm St
 Hudson, OH 44236
 H: (330)554-0531
 C: (330)245-6356

201 **maggies room**
28-1/2" W 61-3/4" H
Window, Double-Hung (DG)



Window: Acclaim™ Double-Hung (DG), 1:1, Slope Sill, Insert Frame, Traditional Checkrail, Exterior White, Interior White
Performance Calculator: PG Rating: 40 | DP Rating: + 40 / - 40 **Glass:** All Sash: High Performance SmartSun Glass, No Pattern **Hardware:** White **Screen:** Fiberglass, Full Screen **Grille Style:** No Grille **Misc:** Wood Insert Small Cap - , RBA Cleveland will remove existing wood window sashes to set the new window into the existing wood frame. This type of installation will typically result in a loss of glass area. A new interior stop may be required and will be provided by RBA Cleveland in an unfinished pine that will the homeowners responsibility to paint or stain. On the exterior RBA Cleveland will finish the new window with color matched aluminum coil to marry back to existing wood window frame as minimal as possible.
 Make this a db***** **Construction:** 2nd Floor install (1), LSWP Per opening (1), R & R Shutter (1) **Material:** 1 3/8" Modern Stop - 10ft (2), Caulk -White Interior (0.25), Coil - White (1), Caulk -White Exterior (2.5) **Sill Angle:** FS°

UNIT NOTES

DB, SHIM UP, extra back-caulk
 Keep locked

UNIT CONSTRUCTION

2nd Floor install	1
LSWP Per opening	1
R & R Shutter	1

UNIT MATERIALS

CASING INNOVATIONS POPLAR	1 3/8" Modern Stop - 10ft	2 x 10ft
CAULK	Caulk -White Interior	0.25 tubes
COIL	Coil - White	1 roll
CAULK	Caulk -White Exterior	2.5 tubes



201

dba: RENEWAL BY ANDERSEN OF CLEVELAND

Legal Name: Renewal by Andersen LLC | License # (null)
17450 Engle Lake Drive, Suite 108 | Middleburg Heights, OH 44130
Phone: 216-503-6200 | Fax: 216-573-1438 |
rbaclevelandorders@andersencorp.com
Measure Tech: Santino Owen, (330)807-5693

David Dunne
120 Elm St
Hudson, OH 44236
H: (330)554-0531
C: (330)245-6356

UNIT PHOTOS



Image 1



202

dba: RENEWAL BY ANDERSEN OF CLEVELAND

Legal Name: Renewal by Andersen LLC | License # (null)
 17450 Engle Lake Drive, Suite 108 | Middleburg Heights , OH 44130
 Phone: 216-503-6200 | Fax: 216-573-1438 |
 rbaclevelandorders@andersencorp.com
 Measure Tech: Santino Owen, (330)807-5693

David Dunne
 120 Elm St
 Hudson, OH 44236
 H: (330)554-0531
 C: (330)245-6356

202 Primary Bedroom
59" W 40" H
Window, Casement - Triple



Window: Acclaim™ Casement Triple, 1:1:1, Left Vent / Stat / Right Vent, Base Frame, Exterior White, Interior White

Performance Calculator: PG Rating: 40 | DP Rating: + 40 / - 40 **Glass:** All Sash: High Performance SmartSun Glass, No

Pattern **Hardware:** White **Screen:** Aluminum, Full Screen **Grille Style:** Grilles Between Glass (GBG) **Grille Pattern:** All Sash:

Colonial 2w x 3h **Misc:** Wood Full Frame Capping - Pine, RBA Cleveland will remove existing wood window, all interior trim, and any needed exterior trim to bring the opening back to the framing of the house. The new window will be installed inside of the rough opening and color matched coil will be used to cap back to the existing exterior siding. On the interior a new interior wood trim kit in unfinished pine will be installed.

ENTER MOULDING SIZE & STYLE: **Construction:** 2nd Floor install (1), Insert as Full Frame (1), LSWP Per opening (1), Build Trim Kit on Site (1), Stool and Apron (1), Steel Pan (1) **Material:** *Casing Innovations 350-91 in 3" wide Poplar - 10Ft* (4), 1x4 S4S - 8ft (2), Stool 3 1/2" STD Bevel (5/4 x 4) 8ft (1), 1x4x8ft #2 Pine (2), Coil - White (0.15), Caulk -White Exterior (3), Caulk -White Interior (0.25)

UNIT NOTES

Exterior sash - sash is 59w by 40h

Pl-pl 63-3/4light by 45-3/4

UNIT CONSTRUCTION

2nd Floor install	1
Insert as Full Frame	1
LSWP Per opening	1
Build Trim Kit on Site	1
Stool and Apron	1
Steel Pan	1

UNIT MATERIALS

CUSTOM	*Casing Innovations 350-91 in 3" wide Poplar - 10Ft*	4 PER UNIT
CASING INNOVATIONS POPLAR	1x4 S4S - 8ft	2 x 8ft



202

dba: RENEWAL BY ANDERSEN OF CLEVELAND

Legal Name: Renewal by Andersen LLC | License # (null)
17450 Engle Lake Drive, Suite 108 | Middleburg Heights, OH 44130
Phone: 216-503-6200 | Fax: 216-573-1438 |
rbaclevelandorders@andersencorp.com
Measure Tech: Santino Owen, (330)807-5693

David Dunne
120 Elm St
Hudson, OH 44236
H: (330)554-0531
C: (330)245-6356

CASING INNOVATION NS POPLAR Stool 3 1/2" STD Bevel (5/4 x 4) 8ft 1 x 8ft

LUMBER - #2 FRAMING 1x4x8ft #2 Pine 2 eas

COIL Coil - White 0.15 rolls

CAULK Caulk -White Exterior 3 tubes

CAULK Caulk -White Interior 0.25 tubes

UNIT PHOTOS



Image 1



Image 2



203

dba: RENEWAL BY ANDERSEN OF CLEVELAND

Legal Name: Renewal by Andersen LLC | License # (null)
 17450 Engle Lake Drive, Suite 108 | Middleburg Heights, OH 44130
 Phone: 216-503-6200 | Fax: 216-573-1438 |
 rbaclevelandorders@andersencorp.com
 Measure Tech: Santino Owen, (330)807-5693

David Dunne
 120 Elm St
 Hudson, OH 44236
 H: (330)554-0531
 C: (330)245-6356

203 Primary Bedroom
39" W 40" H
Window, Casement - Double



Window: Acclaim™ Casement Double, Vented, Base Frame, Exterior White, Interior White **Performance Calculator:** PG Rating: 40 | DP Rating: + 40 / - 40 **Glass:** All Sash: High Performance SmartSun Glass, No Pattern **Hardware:** White **Screen:** Aluminum, Full Screen **Grille Style:** Grilles Between Glass (GBG) **Grille Pattern:** All Sash: Colonial 2w x 3h **Misc:** Wood Full Frame Capping - Pine, RBA Cleveland will remove existing wood window, all interior trim, and any needed exterior trim to bring the opening back to the framing of the house. The new window will be installed inside of the rough opening and color matched coil will be used to cap back to the existing exterior siding. On the interior a new interior wood trim kit in unfinished pine will be installed.

ENTER MOULDING SIZE & STYLE: **Construction:** 2nd Floor install (1), Insert as Full Frame (1), LSWP Per opening (1), Build Trim Kit on Site (1), Stool and Apron (1), Steel Pan (1) **Material:** *Casing Innovations 350-91 in 3" wide Poplar - 10Ft* (4), 1x4 S4S - 8ft (2), Stool 3 1/2" STD Bevel (5/4 x 4) 8ft (1), 1x4x8ft #2 Pine (2), Coil - White (0.15), Caulk -White Exterior (2), Caulk -White Interior (0.25)

UNIT NOTES

Exterior sash - sash is 39w by 40h
 Pl-pl 43-3/4w by 46h

UNIT CONSTRUCTION

2nd Floor install	1
Insert as Full Frame	1
LSWP Per opening	1
Build Trim Kit on Site	1
Stool and Apron	1
Steel Pan	1

UNIT MATERIALS

CUSTOM	*Casing Innovations 350-91 in 3" wide Poplar - 10Ft*	4 PER UNIT
CASING INNOVATIONS POPLAR	1x4 S4S - 8ft	2 x 8ft



203

dba: RENEWAL BY ANDERSEN OF CLEVELAND

Legal Name: Renewal by Andersen LLC | License # (null)
17450 Engle Lake Drive, Suite 108 | Middleburg Heights, OH 44130
Phone: 216-503-6200 | Fax: 216-573-1438 |
rbaclevelandorders@andersencorp.com
Measure Tech: Santino Owen, (330)807-5693

David Dunne
120 Elm St
Hudson, OH 44236
H: (330)554-0531
C: (330)245-6356

CASING **Stool 3 1/2" STD Bevel (5/4 x 4) 8ft** **1 x 8ft**
INNOVATIO
NS POPLAR

LUMBER - **1x4x8ft #2 Pine** **2 eas**
#2 FRAMING

COIL **Coil - White** **0.15 rolls**

CAULK **Caulk -White Exterior** **2 tubes**

CAULK **Caulk -White Interior** **0.25 tubes**

UNIT PHOTOS



Image 1



Image 2



204

dba: RENEWAL BY ANDERSEN OF CLEVELAND

Legal Name: Renewal by Andersen LLC | License # (null)
 17450 Engle Lake Drive, Suite 108 | Middleburg Heights , OH 44130
 Phone: 216-503-6200 | Fax: 216-573-1438 |
 rbaclevelandorders@andersencorp.com
 Measure Tech: Santino Owen, (330)807-5693

David Dunne
 120 Elm St
 Hudson, OH 44236
 H: (330)554-0531
 C: (330)245-6356

204 Primary Bedroom
55" W 64" H
Window, Casement - Double



Window: Acclaim™ Casement Double, Vented, Base Frame, Exterior White, Interior White **Performance Calculator:** PG Rating: 35 | DP Rating: + 35 / - 35 **Glass:** All Sash: High Performance SmartSun Glass, No Pattern **Hardware:** White **Screen:** Aluminum, Full Screen **Grille Style:** Grilles Between Glass (GBG) **Grille Pattern:** All Sash: Colonial 2w x 5h **Misc:** Wood Full Frame Capping - Pine, RBA Cleveland will remove existing wood window, all interior trim, and any needed exterior trim to bring the opening back to the framing of the house. The new window will be installed inside of the rough opening and color matched coil will be used to cap back to the existing exterior siding. On the interior a new interior wood trim kit in unfinished pine will be installed.

ENTER MOULDING SIZE & STYLE: **Construction:** 2nd Floor install (1), Insert as Full Frame (1), LSWP Per opening (1), Build Trim Kit on Site (1), Stool and Apron (1), Steel Pan (1) **Material:** *Casing Innovations 350-91 in 3" wide Poplar - 10Ft* (4), 1x4 S4S - 8ft (4), Stool 3 1/2" STD Bevel (5/4 x 4) 8ft (1), 1x4x8ft #2 Pine (2), Coil - White (0.15), Caulk -White Exterior (2), Caulk -White Interior (0.25)

UNIT NOTES

Exterior Sash-sash 55w by 64h
 Pl-pl 59-3/4w x 69-3/4h

UNIT CONSTRUCTION

2nd Floor install	1
Insert as Full Frame	1
LSWP Per opening	1
Build Trim Kit on Site	1
Stool and Apron	1
Steel Pan	1

UNIT MATERIALS

CUSTOM	*Casing Innovations 350-91 in 3" wide Poplar - 10Ft*	4 PER UNIT
CASING INNOVATIONS POPLAR	1x4 S4S - 8ft	4 x 8ft



204

dba: RENEWAL BY ANDERSEN OF CLEVELAND

Legal Name: Renewal by Andersen LLC | License # (null)
17450 Engle Lake Drive, Suite 108 | Middleburg Heights, OH 44130
Phone: 216-503-6200 | Fax: 216-573-1438 |
rbaclevelandorders@andersencorp.com
Measure Tech: Santino Owen, (330)807-5693

David Dunne
120 Elm St
Hudson, OH 44236
H: (330)554-0531
C: (330)245-6356

CASING INNOVATION NS POPLAR Stool 3 1/2" STD Bevel (5/4 x 4) 8ft 1 x 8ft

LUMBER - #2 FRAMING 1x4x8ft #2 Pine 2 eas

COIL Coil - White 0.15 rolls

CAULK Caulk -White Exterior 2 tubes

CAULK Caulk -White Interior 0.25 tubes

UNIT PHOTOS



Image 1



Image 2



205

dba: RENEWAL BY ANDERSEN OF CLEVELAND

Legal Name: Renewal by Andersen LLC | License # (null)
 17450 Engle Lake Drive, Suite 108 | Middleburg Heights, OH 44130
 Phone: 216-503-6200 | Fax: 216-573-1438 |
 rbaclevelandorders@andersencorp.com
 Measure Tech: Santino Owen, (330)807-5693

David Dunne
 120 Elm St
 Hudson, OH 44236
 H: (330)554-0531
 C: (330)245-6356

205 Primary Bedroom 39" W 40" H Window, Casement - Double



Window: Acclaim™ Casement Double, Vented, Base Frame, Exterior White, Interior White **Performance Calculator:** PG Rating: 40 | DP Rating: + 40 / - 40 **Glass:** All Sash: High Performance SmartSun Glass, No Pattern **Hardware:** White **Screen:** Aluminum, Full Screen **Grille Style:** Grilles Between Glass (GBG) **Grille Pattern:** All Sash: Colonial 2w x 3h **Misc:** Wood Full Frame Capping - Pine, RBA Cleveland will remove existing wood window, all interior trim, and any needed exterior trim to bring the opening back to the framing of the house. The new window will be installed inside of the rough opening and color matched coil will be used to cap back to the existing exterior siding. On the interior a new interior wood trim kit in unfinished pine will be installed.

ENTER MOULDING SIZE & STYLE: **Construction:** 2nd Floor install (1), Insert as Full Frame (1), LSWP Per opening (1), Build Trim Kit on Site (1), Stool and Apron (1), Steel Pan (1) **Material:** *Casing Innovations 350-91 in 3" wide Poplar - 10Ft* (4), 1x4 S4S - 8ft (2), Stool 3 1/2" STD Bevel (5/4 x 4) 8ft (1), 1x4x8ft #2 Pine (2), Coil - White (0.15), Caulk -White Exterior (2), Caulk -White Interior (0.25)

UNIT NOTES

Exterior sash - sash is 39w by 40h
 Pl-pl 43-5/8w by 46-5/8h

UNIT CONSTRUCTION

2nd Floor install	1
Insert as Full Frame	1
LSWP Per opening	1
Build Trim Kit on Site	1
Stool and Apron	1
Steel Pan	1

UNIT MATERIALS

CUSTOM	*Casing Innovations 350-91 in 3" wide Poplar - 10Ft*	4 PER UNIT
CASING INNOVATIONS POPLAR	1x4 S4S - 8ft	2 x 8ft



205

dba: RENEWAL BY ANDERSEN OF CLEVELAND

Legal Name: Renewal by Andersen LLC | License # (null)
17450 Engle Lake Drive, Suite 108 | Middleburg Heights, OH 44130
Phone: 216-503-6200 | Fax: 216-573-1438 |
rbaclevelandorders@andersencorp.com
Measure Tech: Santino Owen, (330)807-5693

David Dunne
120 Elm St
Hudson, OH 44236
H: (330)554-0531
C: (330)245-6356

CASING **Stool 3 1/2" STD Bevel (5/4 x 4) 8ft** **1 x 8ft**
INNOVATIO
NS POPLAR

LUMBER - **1x4x8ft #2 Pine** **2 eas**
#2 FRAMING

COIL **Coil - White** **0.15 rolls**

CAULK **Caulk -White Exterior** **2 tubes**

CAULK **Caulk -White Interior** **0.25 tubes**

UNIT PHOTOS



Image 1



Image 2



201

dba: RENEWAL BY ANDERSEN OF CLEVELAND

Legal Name: Renewal by Andersen LLC | License # (null)
17450 Engle Lake Drive, Suite 108 | Middleburg Heights , OH 44130
Phone: 216-503-6200 | Fax: 216-573-1438 |
rbaclevelandorders@andersencorp.com
Measure Tech: Santino Owen, (330)807-5693

David Dunne
120 Elm St
Hudson, OH 44236
H: (330)554-0531
C: (330)245-6356

201

Maggie's room

Misc



Misc: Misc, Customer Casing/Trim, Notes, Quantity 1, Db to match the others **Construction:** None **Material:** None

UNIT NOTES

Db to match the others

UNIT CONSTRUCTION

UNIT MATERIALS

UNIT PHOTOS

Installation Invoice

David Dunne
120 Elm St
Hudson, OH 44236
H: (330)554-0531
C: (330)245-6356

DESCRIPTION	QUANTITY	UNIT PRICE	TOTAL
Base Unit Installation Charges, Full Frame & EJ Frame			
Base Unit Installation Charges, Insert Frame & Base Frame			
Install Double-Hung Window-DG (Base Frame), 90-99.99 UI	1	\$128.00	\$128.00
Install Casement-Triple Window (Base Frame), 90-99.99 UI	1	\$128.00	\$128.00
Install Casement-Double Window (Base Frame), 70-79.99 UI	2	\$128.00	\$256.00
Install Casement-Double Window (Base Frame), 110-119.99 UI	1	\$128.00	\$128.00
Base Unit Installation Charges, Patio Doors			
Base Unit Installation Charges, Entry Doors			
Construction Charges			
LSWP Per opening , 202, 203, 204, 205, 201	5	\$25.00	\$125.00
Stool and Apron, 202, 203, 204, 205	4	\$20.00	\$80.00
Steel Pan, 202, 203, 204, 205	4	\$25.00	\$100.00
R & R Shutter, 201	1	\$10.00	\$10.00
2nd Floor install , 202, 203, 204, 205, 201	5	\$15.00	\$75.00
Insert as Full Frame , 202, 203, 204, 205	4	\$30.00	\$120.00
Build Trim Kit on Site, 202, 203, 204, 205	4	\$30.00	\$120.00

SUBTOTAL

\$ 1,270.00

Additional Items

TOTAL

\$



RENEWAL
by **ANDERSEN**
FULL-SERVICE WINDOW & DOOR REPLACEMENT

WINDOWS
PATIO DOORS



Recognized by J.D. Power for
**“#1 in Customer Satisfaction
with Window and Patio Door
Retailers and Manufacturers”**

The Better Way to a Better Window®

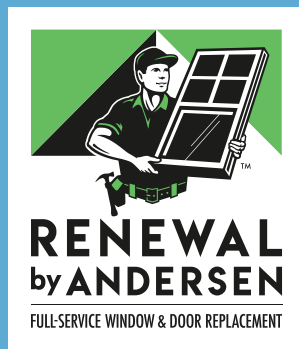

It's time to fall in love with your home all over again.

Whether you're replacing your old windows because they're broken, drafty, or require too much maintenance, we know you have lots of questions. There are many considerations – glass, window frame material, style, hardware, color, and warranty to name a few. But most importantly, you want the job done right. You want it to be a smooth, easy process, and you want it to be done by a company you can trust – before, during, and after installation.

That's why you want Renewal by Andersen. We offer a start-to-finish process. All you need to do is sit back and relax, knowing you made the right choice in window replacement.



The Renewal by Andersen Process is Easy...



Get Started

Give us a call, visit our website, or stop by one of our showrooms to schedule a **FREE** in-home consultation.



Set Up a Time to Meet

We will meet in the comfort of your home at a time convenient for you to discuss your project.



Sit Back and Relax

You've selected a professional company that can handle the entire replacement process from start to finish.



CONTENTS

3	Signature Service
4	Certified Master Installer
5	Fibrex® Material
6	The Renewal by Andersen Difference
8	Engineering and Innovation
10	Choosing Windows
12	Double-Hung Windows
14	Casement and Awning Windows
16	Gliding Windows
18	Picture Windows
20	Specialty Windows
22	Projection Windows
24	Grille Options
26	Insect Screen Options
27	Hardware Finish Options
28	Choosing Patio Doors
29	Frenchwood® Hinged Patio Doors
30	Frenchwood® Gliding Patio Doors
31	Narroline® Gliding Patio Doors
32	Perma-Shield® Gliding Patio Doors
33	Patio Door Hardware Options
34	Patio Door Engineering
35	Patio Door Options
36	Glass Options
BACK	Warranty



the best **PEOPLE**
 a superior **PROCESS**
 an exclusive **PRODUCT**

Replace Old Expectations

We believe your Renewal by Andersen experience is about more than just windows. It's about caring for you and your home, every step of the way.

We own our entire process, from start to finish. What does that mean for you? It means we listen. It means we measure, we build, and we install. And it means we promise to stand by our product – today, tomorrow, and years into the future.¹

A Legacy That Looks to the Future

For more than a century, Andersen® products and patents have revolutionized the window and door industry. We pair that legacy of quality and innovation with a skilled team of specialists who are dedicated to making sure your window replacement is the best home improvement project you've ever done.

From Our Family to Yours

Your home is unique. It shouldn't be treated like every other house on the block. This is the place where you and your family make memories and celebrate moments, both big and small. We want to make sure your new windows suit your home life.

You want your replacement products to last, so whom you choose to do your project is important.¹ When you work with Renewal by Andersen, you know you'll get an exclusive product that is durable, customizable, and beautiful. And you know we'll take care of you – and your home – from start to finish, and beyond.



From consultation to installation, Renewal by Andersen offers one-company accountability backed by a legacy of excellence. We're proud to work with the best people, offer a superior, start-to-finish replacement process, and provide you with exclusive, industry-leading products. **That's Renewal by Andersen Signature Service.**

FEEL CONFIDENT TRUST YOUR HOME TO THE MASTERS

By working with the best people across the board, we're able to push industry installation standards to new heights. Our Certified Master Installers are the best team for the job – the team we trust to handle the windows built just for you. Rigorously trained, respectful, and friendly, you'll see why we're proud to call them Certified Master Installers.



A quality experience is in the details

We've long understood that all the care, pride, and craftsmanship we put into our products would mean little without professional installation. It's from these standards that we created our Certified Master Installer program.



Our standards are tough

Prior to certification, we require all trainers and installers at our certified locations to demonstrate their knowledge of construction materials, building codes, and installation methods. We understand you work hard for your home, and we want you to be as comfortable as possible throughout the installation process.



We take a unique approach

Not only do we provide a professional process from start to finish, our Certified Master Installer program takes this to the next level by placing your new windows and patio doors in the hands of skilled master installers with years of experience.



Only the best people make the cut

We take pride in setting the highest standards in the market, with no stone left unturned. This includes the men and women installing your windows. We're proud to put our name in their hands.



What are Renewal by Andersen® windows made of?

All of our windows are made of Fibrex® material, a revolutionary composite made from reclaimed wood fiber blended with a polymer. This gives our windows the strength and durability of wood and the low-maintenance features of vinyl, while greatly limiting thermal transmittance that can be found in other window materials such as metal.

Unlike many other window materials, Fibrex composite material won't flake, rust, blister, peel, crack, pit, or corrode¹. It is also two times stronger than vinyl and resists warping and bowing. Never worry about scraping or painting your windows again.

ENGINEERED WITH
FIBREX[®]
MATERIAL



Smart Materials

Fibrex material is twice as strong as vinyl, so weathertight seals stay weathertight.

Color Choice

Our unique process fuses color to Fibrex material for long-lasting beauty. And it offers dark exterior colors not available on most other replacement windows.

Exceptional Comfort

Fibrex material blocks thermal transfer nearly 700 times better than aluminum to help reduce heating and cooling bills.

Outstanding Durability

Fibrex material retains its stability and rigidity in all climates.¹

	FIBREX MATERIAL	VINYL	ALUMINUM	WOOD
Insulating Properties	✓	✓		✓
Low Maintenance	✓	✓	✓	
Resistance to Decay/Corrosion	✓	✓		
Structural Rigidity	✓		✓	✓
Durability	✓		✓	✓
Color Choices	✓			✓
Dark Color Performance	✓		✓	✓

THE RENEWAL BY ANDERSEN DIFFERENCE

Peace of Mind Comes Standard

Renewal by Andersen is the exclusive, full-service window replacement division of Andersen Corporation.

We were founded with a mission to change the window replacement industry by offering a 'different and better' window replacement experience. We own the process from sales through installation and service, and we promise one-stop accountability.

See for yourself the difference our standards for quality and service will make in your window and door replacement experience. We make it easy.

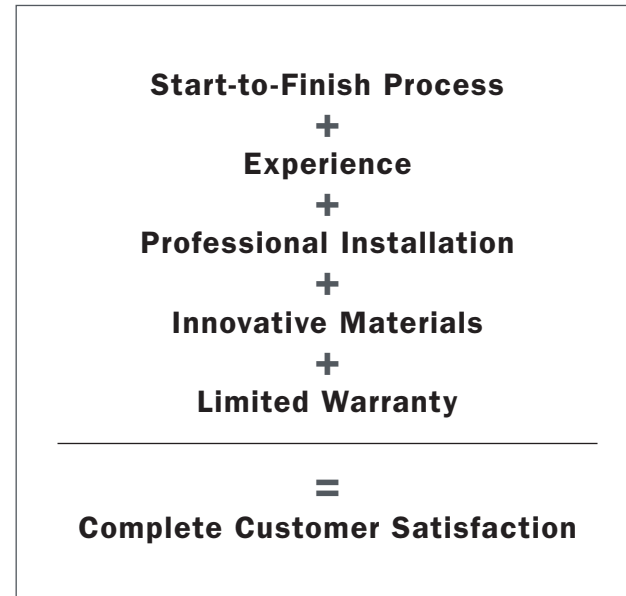

Double-Hung Windows / White Exterior



An Unmatched History

Founded in 1903, Andersen Corporation quickly revolutionized the way windows were built and installed. Over the years, Andersen has introduced many industry firsts. Andersen continues to be a leader in producing products that last longer, look better, and function smoothly for many years.

To this day, Andersen Corporation operates under the core principles founder Hans Andersen put in place over a century ago. When you purchase Renewal by Andersen® windows, you're purchasing time-tested innovation – and a piece of history that will last for years to come.¹



OVER
117
YEARS
 OF
 Innovation
 AND
 Excellence

Customer Service



Our professional sales consultants and expert installation teams are with you every step of the way.

Products



Innovative products and features are available throughout our product line.

Professional Installation



**CERTIFIED
MASTER
INSTALLER**

Our installers are experienced and understand the many critical steps involved with installing your new windows and doors properly.

Nation's Best Warranty



We offer one of the strongest limited warranties of any window and door manufacturer, and it is fully transferable should you sell your home.¹

CUSTOMER-FOCUSED ENGINEERING AND INNOVATION

YEARS OF PROVEN INNOVATION RESULTS IN PRODUCTS AND PEOPLE YOU CAN TRUST.



EXTERIOR

FUNCTIONAL REQUIREMENTS:
- Thermal analysis
- Structural analysis

ENGINEERING SOLUTION:
- Increase product performance

HOMEOWNER BENEFIT:
A strong balance of energy efficiency and strength, offering some of the largest casement window sizes.



FUNCTIONAL REQUIREMENTS:
- Hardware mechanics

ENGINEERING SOLUTION:
- Low profile hardware with fold-down nesting handle

HOMEOWNER BENEFIT:
Nesting casement window hardware reduces interference with window treatments.



Casement Window
Red Rock Exterior
Simulated Double-Hung Farmhouse Grilles

FUNCTIONAL REQUIREMENTS:
- Strengthen corner joints
- Increase window beauty

ENGINEERING SOLUTION:
- Utilize mortise-and-tenon corner joint

HOMEOWNER BENEFIT:
Unique corner key design increases structural integrity and beauty.



FUNCTIONAL REQUIREMENTS:
- Ease of cleaning

ENGINEERING SOLUTION:
- Incorporate hardware that allows for accessibility

HOMEOWNER BENEFIT:
Ease and safety while cleaning your new windows - no more ladders!



With safety and convenience in mind, our double-hung, casement and gliding windows are easy to clean from the interior of your home.

FUNCTIONAL REQUIREMENTS:
- Reduce air infiltration

ENGINEERING SOLUTION:
- Integrate weatherstrips into side jambs

HOMEOWNER BENEFIT:
Reinforced seals provide a high level of protection against drafts.

FUNCTIONAL REQUIREMENTS:
- Water management

ENGINEERING SOLUTION:
- Gravity
- Angled sill

HOMEOWNER BENEFIT:
Sloped sill drains water away from the window.



INTERIOR

FUNCTIONAL REQUIREMENTS:
- Sash design options and historical compatibility

ENGINEERING SOLUTION:
- Integrate interior and exterior grilles into window design

HOMEOWNER BENEFIT:
Add grilles to the inside, outside, and even between the glass of your new window.



FUNCTIONAL REQUIREMENTS:
- Window operation

ENGINEERING SOLUTION:
- Incorporate balancer system

HOMEOWNER BENEFIT:
Effortlessly open and close your window.



Double-Hung Window
Pine Interior / Custom Grilles
Satin Nickel Estate™ Hardware

CHOOSING RENEWAL BY ANDERSEN® WINDOWS IS EASY...

WE MAKE IT EASY SO YOU CAN SIT BACK AND RELAX, KNOWING YOU'VE SELECTED A PROFESSIONAL, START-TO-FINISH WINDOW AND DOOR REPLACEMENT COMPANY.

The Renewal by Andersen process starts with our consultative sales approach. Our experienced sales representatives will work with you to find solutions to enhance your home's functionality, energy efficiency, and beauty.

1

Select Window Styles

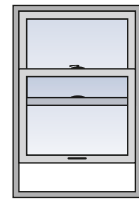

Double-Hung Window
PAGE 12

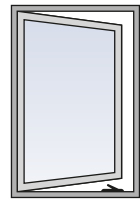

Casement Window
PAGE 14

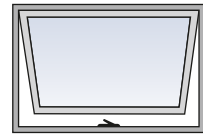

Awning Window
PAGE 14

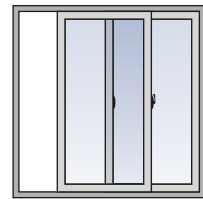

Gliding Window
PAGE 16

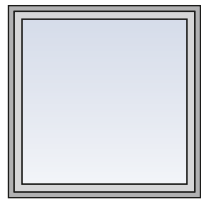

Picture Window
PAGE 18

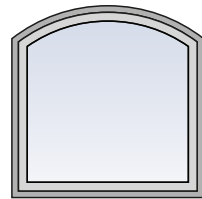

Specialty Window
PAGE 20

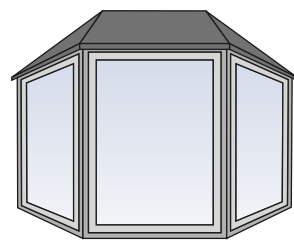

Projection Window
PAGE 22

2

Select Colors³

Real wood interior veneers can be stained or painted to match your decor

Interior



Real Maple



Real Pine



Real Oak

Interior/Exterior



White



Canvas



Sandtone



Terratone



Dark Bronze



Black

Exterior



Cocoa Bean



Forest Green



Red Rock

3

Select Hardware and Options

Grilles page 24

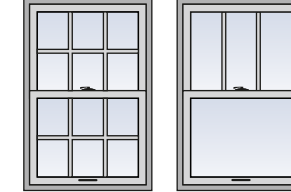

Insect Screens page 26



Hardware Finish page 27



Glass page 36

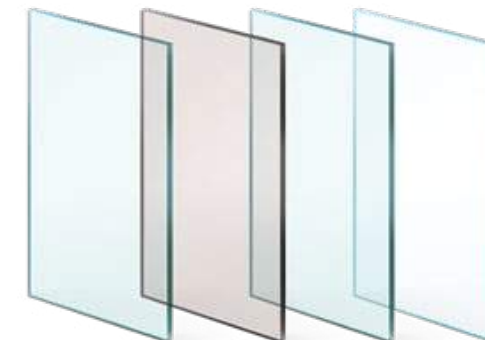

Visit Us Online at
RENEWALBYANDERSEN.COM



See independent homeowner reviews and completed projects from your neighborhood.

Explore how new windows will look in your home.

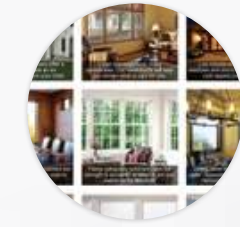
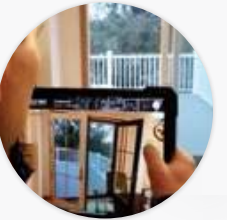

Get ideas and be inspired by our window options.

Five Key Environmental and Energy Solutions

While we care about you and your home, we also care deeply for the world in which we all live.

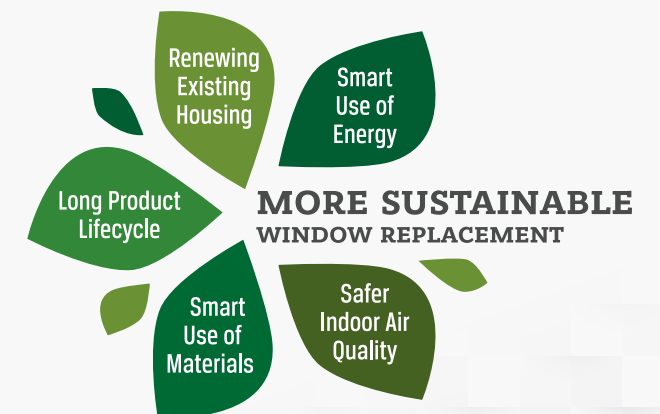

See our Environmental and Energy Solutions Brochure for additional information.

DOUBLE-HUNG WINDOWS

This classic window style is an excellent choice no matter where you live. Choose gently curved contemporary or squared traditional check Rails.

CONVENIENT

Both top and bottom sash tilt in for easy cleaning.

ELEGANT

Traditional look of mortise-and-tenon joints styling.

ACCURATE

Fits perfectly in many restoration and renovation projects.

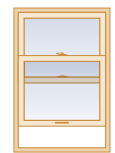

Double-Hung Equal Window



Double-Hung Cottage Style Window



Double-Hung Reverse Cottage Style Window



Combination Window

EXPRESS YOUR STYLE

Check Rail Options



Contemporary



Traditional



“My new windows look beautiful and can be opened from the bottom or top.”

CAROL P.

Double-Hung Windows / White Interior



Double-Hung Windows / White Interior / Colonial Grilles



Double-Hung Windows / Maple Interior / Colonial Grilles



Double-Hung Windows / White Interior



Double-Hung Windows / Black Interior



Double-Hung Windows / White Exterior / Colonial Grilles

CASEMENT AND AWNING WINDOWS

Casement windows catch a breeze and direct fresh air indoors, allowing the most ventilation of any window style. Awning windows let in fresh air, even on rainy days!

EASY

Casement windows open wide to allow easy cleaning of outside glass from the inside⁴ and can be hinged from the right or left.

SECURE

One lever positioned in an easy-to-reach location securely locks the casement window at multiple points for a weathertight seal.

CONVENIENT

Awning windows are recommended for use over cabinets, counters, or areas where opening and closing require a reach.

EFFICIENT

Casement and awning windows are our most energy-efficient ventilating window styles.

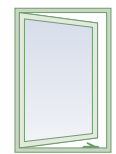

Casement Window

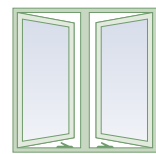

Casement Double Window

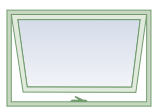

Awning Window



Combination Window

EXPRESS YOUR STYLE



“Renewal by Andersen was by far the best investment I’ve ever made for my home.”
PAUL M.

Casement and Picture Combination Windows / Oak Interior



Casement and Specialty Equal Leg Arch Combination Window / Oak Interior / Colonial Grilles



Casement Windows / White Interior / Simulated 2¼" Double-Hung Check Rail / Modified Colonial Grilles



Awning Window / Pine Interior



Casement and Picture Windows / White Interior

GLIDING WINDOWS

Whether you're creating a new look or matching the original window style of your home, maximize your view with slim, easy-to-slide, contemporary gliding windows.

BEAUTIFUL

Narrow, contoured frames allow more glass viewing area.

VERSATILE

Both sashes slide, so you can open either the left side, the right side, or a portion of both.⁵

RELIABLE

Fibrex® material tracks are shaped for easier cleaning and will not pit, rust, or corrode.¹

UNIQUE

A great solution when a projecting window interferes with walkways, patios, decks, or landscaping.

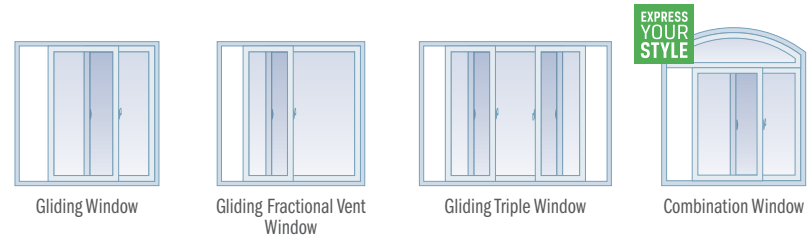

“Best investment in our home that we have made.”

STEVEN E.

Gliding Triple Window and Gliding Window / White Interior



Gliding Triple Window / White Interior



Gliding Fractional Vent Window / Terratone Interior



Gliding Triple Window and Gliding Fractional Vent Window Terratone Interior



Gliding Window Maple Interior

How Window Performance Is Rated

Energy Efficiency Rating

To help homeowners, in 1992 the National Fenestration Rating Council® (NFRC) established an independent third-party rating, certification, and labeling program for windows, doors, and skylights (fenestration products). Renewal by Andersen displays the NFRC label on all of its windows. This label means that the entire window unit has been rated and certified, not just the center of the glass or individual components. See our Energy Efficiency brochure for additional information.

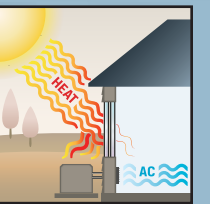

Warm Weather Performance



Cool Weather Performance

 National Fenestration Rating Council®	 RENEWAL by ANDERSEN	ENERGY PERFORMANCE RATINGS	
		U-Factor 0.26 (U.S./I-P)	Solar Heat Gain Coefficient 1.48 (Metric/SI)
ADDITIONAL PERFORMANCE RATINGS		Visible Transmittance 0.53	Air Infiltration 0.00
<small>Manufacturers disclose that these ratings conform to NFRC procedures for determining whole-product performance. NFRC ratings are determined for a fixed set of environmental conditions and a specific product size. NFRC does not recommend any product and does not warrant the suitability of any product for any specific use. Contact manufacturer's literature for other product performance information.</small>			

Sample label shown

PICTURE WINDOWS

Transform your home with picture windows that can stand alone beautifully or can be combined with other window styles for added curb appeal.

ADAPTABLE

Match or change your home's appearance by combining picture windows with other windows.

STRONG

Using strong Fibrex® material frames, our picture windows easily support the weight of the heavy glass commonly needed for large picture windows.

VERSATILE

Like all of our windows, picture window glass is available tempered, tinted, or in a wide variety of decorative patterns.



Picture Window

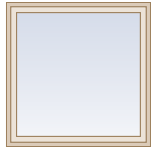

Fixed Picture Window



Combination Window

EXPRESS YOUR STYLE



Picture and Specialty Windows / Terratone Exterior



Picture Windows / Pine Interior

“The new windows are gorgeous and receive rave reviews from our visitors.”
ROBERT R.



Picture Window / White Interior

Schedule Your free In-Home or Virtual Consultation

Call
your local Renewal by Andersen representative

Click over to
RENEWALBYANDERSEN.COM

Visit
your local Renewal by Andersen showroom



Picture Window / White Interior



Picture and Specialty Equal Leg Arch Combination Window / Oak Interior

SPECIALTY WINDOWS

As unique as your home, our specialty windows are custom made and available in many configurations.

VERSATILE

Specialty windows are available in thirteen different shapes and a wide variety of colors, grille patterns, and glass options.

STRONG

Like picture windows, specialty windows don't open, but can be joined to any other window style for maximum design flexibility.⁶

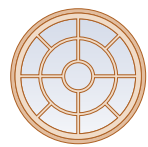

CIRCLE

Renaissance Grilles

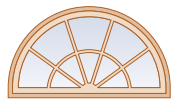

CIRCLE TOP™

Open Hub Sunburst Grilles

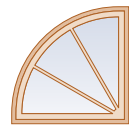

QUARTER CIRCLE

Sunburst Grilles



CHORD

Sunburst Grilles

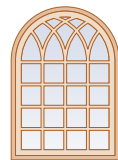

SPRINGLINE™

Gothic Grilles

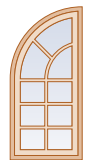

SPRINGLINE™

Unequal Renaissance Grilles

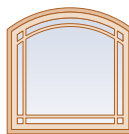

ARCH

Equal Leg Prairie Grilles



ARCH

Unequal Leg Prairie Grilles

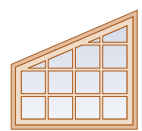

TRAPEZOID

Colonial Grilles

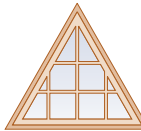

TRIANGLE

Colonial Grilles

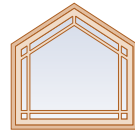

PEAK PENTAGON

Prairie Grilles

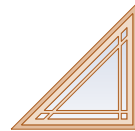

RIGHT TRIANGLE

Prairie Grilles

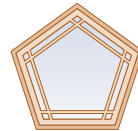

PENTAGON

Prairie Grilles



OCTAGON

Colonial Grilles

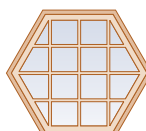

HEXAGON

Colonial Grilles



EXPRESS YOUR STYLE

CUSTOM

Your Shape and Your Grille Pattern



EXPRESS YOUR STYLE

Combination Window

Combination Window



Specialty Equal Leg Arch, Specialty Unequal Leg Arch, and Picture Combination Window / Oak Interior



Specialty Peak Pentagon Windows Sandtone Exterior / Custom and Colonial Grilles



Specialty Springline™ Window Andersen® Frenchwood® Inswing Patio Door / White Interior



Specialty Circle Top™ Specialty Quarter Circle, and Picture Combination Window Sandtone Exterior / Sunburst and Colonial Grilles



Specialty Circle Top™ and Casement Combination Windows / Canvas Interior

PROJECTION WINDOWS

Expand the possibilities with an elegant, gently arched bow window or an angled bay window to make your home feel larger and brighter. Make any room a masterpiece.

VERSATILE

Bay and bow windows can be used as a replacement in most large window openings.

FLEXIBLE

Choose a combination of double-hung, casement, picture, or awning windows.

BAY

Bay windows are available in four projection angles up to a 90° box bay.

BOW

Bow windows sweep away from the wall in a graceful arch of three, four, five, or six windows.

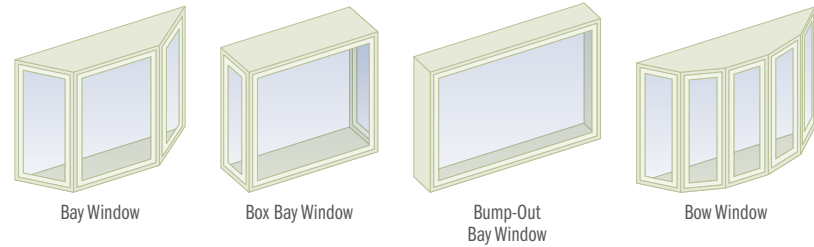

EXPRESS YOUR STYLE

Roof Options⁷



Shake roofs can be stained or painted to match your home

EXPRESS YOUR STYLE

Seat Color Options⁷



SEE OUR BROCHURE FOR DETAILS



Bay Window / White Interior

“Thank you for making our house look beautiful!”

JON M.



Box Bay Window / White Interior



Bay Window / Terracotta Exterior / Concave Copper Roof



Bow Window / Canvas Exterior / Shake Roof



Bow Window / Oak Interior / Colonial Grilles

Customize Your Windows

Renewal by Andersen offers a wide range of creative grille patterns to enhance the look of your home.

All of our grilles are designed to be long lasting¹ with low-maintenance performance. With such a broad range of high-profile grille options, you can match your home's current architecture, change the look and style of your home, or incorporate them into a renovation project for historical accuracy.

Patterns

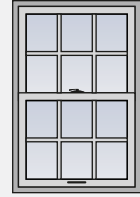

Colonial

Specified number of squares per sash.
Double-hung window shown

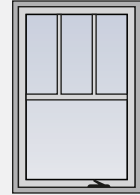

Farmhouse

Two vertical bars meet a wider horizontal rail or bar at the center of the window.
Casement window shown



Prairie

Two vertical and two horizontal bars per sash to form 4-inch corner squares.
Double-hung window shown

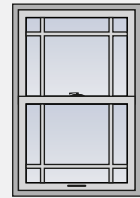

Modified Prairie

Two vertical bars and one horizontal bar per sash.
Double-hung window shown

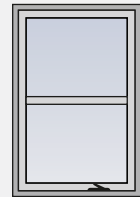

Simulated Double-Hung

Preserve the look of a traditional window.
Casement window shown

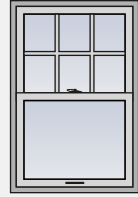

Modified Colonial

Specified number of squares on one sash.
Double-hung window shown

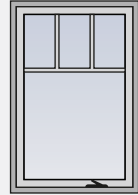

Fractional

Specified number of vertical bars meet a horizontal bar.
Casement window shown

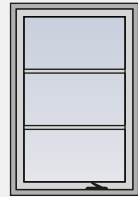

Equal Light

Specified number of horizontal bars, equal distance apart.
Casement window shown



Custom

Create a new pattern or revive one from the past.
Casement window shown



More

Ask your design consultant for more grille options.
Picture window shown

Profiles

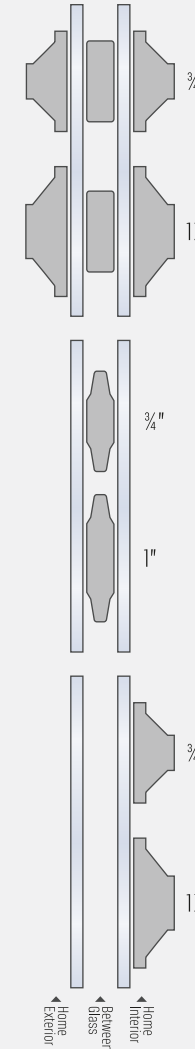

Full Divided Light Grilles

Full divided light grilles provide a visual representation of true divided glass. The option consists of a permanently applied exterior Fibrex® material grille, an aluminum spacer between the glass, and a removable or permanently applied interior grille. Available in two widths and an array of colors.

Grilles Between-the-Glass

Aluminum grilles are permanently installed between the panes during manufacturing, providing the beauty of grilles with the quick cleaning of a smooth glass surface. Available in two widths and an array of colors.

Interior Wood Grilles

Made of hardwood, these grilles snap into clips on the interior of the sash and can be easily removed to make glass cleaning a breeze. Available in two widths.



Casement and Picture Windows / Black Interior / Fractional Grilles



Casement Window / White Interior / Prairie Grilles



Double-Hung Window / Black Exterior / Custom Grilles

INSECT SCREEN OPTIONS

EVEN WHEN IT COMES TO INSECT SCREENS, YOU CAN LET YOUR PERSONAL STYLE GUIDE YOU.

Repel Invaders

Fiberglass insect screens are included with every operable window from Renewal by Andersen. Each is lightweight and designed to be easily removed from the inside of your home for easy cleaning. All insect screens are constructed with an aluminum frame and your choice of fiberglass, aluminum, or our innovative TruScene insect screens. Half insect screens are available on double-hung windows.

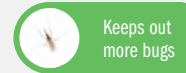

High Transparency

TruScene® Insect Screen

With over 50% more clarity than our standard insect screen,⁹ it's virtually invisible. TruScene insect screens are made with a micro-fine stainless steel mesh that's one-third the diameter of standard screen wire.⁹ That lets more fresh air and sunlight in while keeping most of the smallest insects out.

Patented technology > Superior ventilation > Protection against some of the smallest insects > Lets more light in



Wood-Veneered TruScene Insect Screen

Our wood-veneered TruScene insect screen blends seamlessly into the window frame and can be stained or painted to match your decor. Available on casement and awning windows only.

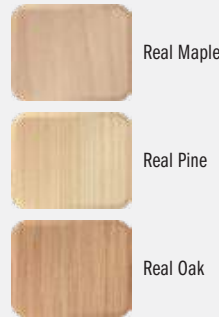

TruScene® Insect Screen



TruScene insect screens are like nothing you've ever seen!

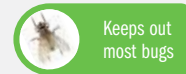

Conventional

Fiberglass Insect Screen

Fiberglass is the most common type of insect screen. It is strong and keeps the majority of bugs out while allowing plenty of air flow.



Aluminum Insect Screen

Our aluminum insect screen has a charcoal powder coating to reduce glare and increase visibility. It is also strong and has good ventilation and corrosion resistance.

HARDWARE FINISH OPTIONS

SOPHISTICATION AND STYLE.

Define Your Style

Not only does Renewal by Andersen® hardware function well, its metal construction is also long lasting.¹ With multiple color options,³ you can match your home's existing colors or change the look by choosing a new color that complements your new windows.

With so many design options, you can create the windows you've always wanted with the design features that are right for you and your home.

Do you want to make your mark? With our Estate Hardware metal finishes, explore the many creative possibilities sure to add charm to your home that others will notice!

Estate™ Hardware



Polished Chrome, Brushed Chrome, Satin Nickel¹⁰, Distressed Nickel



Bright Brass¹⁰, Antique Brass¹⁰, Distressed Bronze¹¹, Oil Rubbed Bronze¹¹



Standard Hardware



White, Canvas, Stone, Dark Bronze, Black

Nesting handles reduce interference with window treatments



Estate Double-Hung Hand Lift / Bright Brass Finish



Estate Casement and Awning Window Handle / Antique Brass Finish



Estate Double-Hung Finger Lift Bright Brass Finish



Estate Double-Hung Window Latch Satin Nickel Finish



Double-Hung Window Latch / White Finish

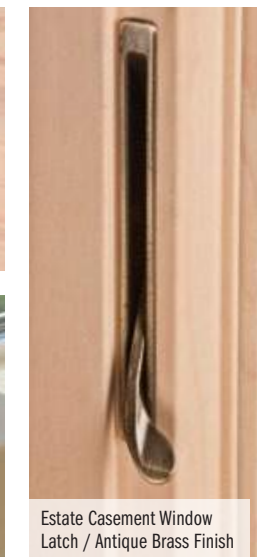

Estate Casement Window Latch / Antique Brass Finish



Estate Gliding Window Latch Distressed Nickel Finish

CHOOSING ANDERSEN® PATIO DOORS IS EASY...

A beautiful and functional patio door can transform the way you use your living space. With more products, colors, and innovation in patio door replacement, we provide the perfect solution to worn-out patio doors.

1

Select Patio Door Style

Choose a traditional or contemporary style patio door.

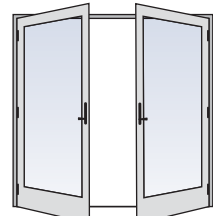

Frenchwood® Hinged Patio Door
PAGE 29

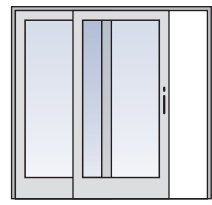

Frenchwood® Gliding Patio Door
PAGE 30

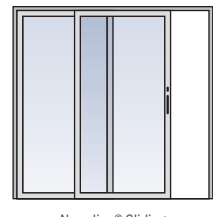

Narroline® Gliding Patio Door
PAGE 31

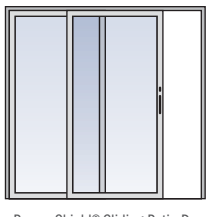

Perma-Shield® Gliding Patio Door
PAGE 32

2

Select Colors³

Choose a color and finish that complements your home's interior and exterior.



PAGE 29-32

3

Select Hardware and Options

Choose from a variety of hardware styles, finishes, locks, and insect screen options.



PAGE 33



Frenchwood Single Open Hinged Inswing Patio Door / White Interior



Frenchwood Double Open Hinged Inswing Patio Door / White Interior / Prairie Grilles



Frenchwood Double Open Hinged Outswing Patio Door / Terratone Exterior / Equal Light Grilles

TRADITIONAL STYLE

FRENCHWOOD® HINGED PATIO DOORS

French doors are steeped in tradition. Ours are no exception, featuring traditional wide-board stile and rail construction with mortise-and-tenon joints. Choose from a variety of interior colors – or stainable oak, maple, and pine.

VERSATILE

Can be installed in most patio door openings, even in place of a gliding patio door.

STRONG

Constructed with a glass fiber-reinforced composite.

DURABLE

Exterior wood door panels are protected with a urethane-based finish.

FLEXIBLE

Provides a large opening for easy access to your home's exterior.

Hinged Inswing Patio Doors Interior view shown

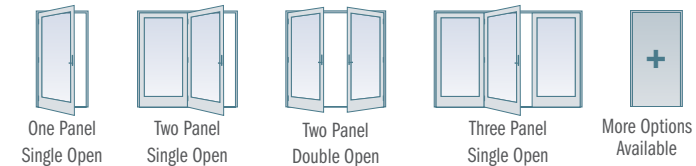

Hinged Outswing Patio Doors¹² Interior view shown



EXPRESS YOUR STYLE Color Options³



The Renewal by Andersen Installation Advantage

You're not just investing in a patio door. You're getting the Renewal by Andersen total solution.

- ✓ Factory authorized installers
- ✓ Protection from the elements during installation
- ✓ Job site setup
- ✓ Removal and disposal of old patio door
- ✓ Preparation of patio door opening
- ✓ Assembly of patio door frame and installation
- ✓ Setting, shimming, insulation, and flashing
- ✓ Hardware adjustment for proper operation
- ✓ Interior finishing
- ✓ Homeowner satisfaction
- ✓ Exterior finishing and sealing
- ✓ Cleanup of construction materials and waste
- ✓ On-site product demonstration

FRENCHWOOD® GLIDING PATIO DOORS

The same familiar style and exceptional features of our French doors are also available in a compact, space-saving design that glides like a dream. Choose from a variety of interior colors – or stainable oak, maple, and pine – to complement your home.

EASY

Door easily slides open on track rollers.

SECURE

Reach-out lock system provides increased security.

APPEALING

French door design in a space-saving gliding door format.

PROTECTED

Frame is covered with a rigid vinyl sheath for an attractive appearance with minimal maintenance.



Frenchwood Gliding Patio Door / Pine Interior



Frenchwood Gliding Patio Door / White Interior / Short Fractional Grilles



Frenchwood Gliding Patio Door / Pine Interior / Custom Grilles

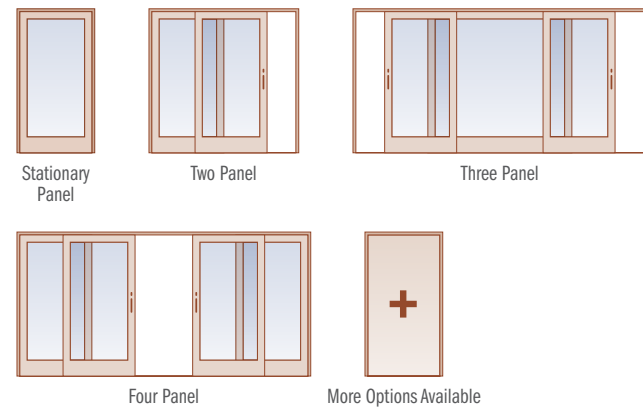

EXPRESS YOUR STYLE Color Options³

INTERIOR

- Real Maple
- Real Pine
- Real Oak
- White
- Canvas¹²
- Sandtone¹²
- Dark Bronze¹²
- Black¹²

EXTERIOR

- White
- Canvas¹²
- Sandtone
- Terratone
- Dark Bronze¹²
- Black¹²
- Cocoa Bean¹²
- Forest Green
- Red Rock¹²

³ Printing limitations prevent exact color duplication of colors and finishes. See your Renewal by Andersen representative for actual color and finish samples. ¹² Available with A-Series patio doors only.

NARROLINE® GLIDING PATIO DOORS

The sleek, modern design of our contemporary gliding patio doors features thin frames for maximum glass area and doors that slide smoothly on dual ball-bearing rollers with self-contained leveling adjusters. A reach-out lock system provides increased security and weathertightness you can see in action.

SIMPLE

Stainable natural pine interior with mortise-and-tenon joints

DURABLE

Exterior wood door panel is protected with a urethane-based finish.



Narroline Gliding Patio Door / Pine Interior



Narroline Gliding Patio Door / Pine Interior



Narroline Gliding Patio Door / White Interior

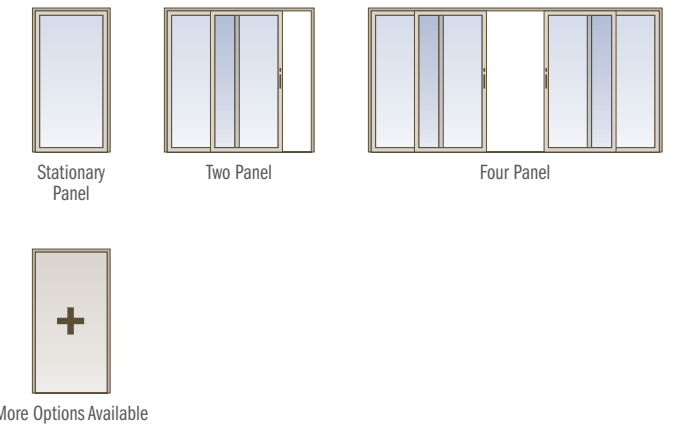

EXPRESS YOUR STYLE Color Options³

INTERIOR

- Real Pine
- Prefinished White

EXTERIOR

- White
- Canvas
- Sandtone
- Terratone
- Dark Bronze
- Black

³ Printing limitations prevent exact color duplication of colors and finishes. See your Renewal by Andersen representative for actual color and finish samples.

PERMA-SHIELD® GLIDING PATIO DOORS

The sleek, modern design of our contemporary gliding patio doors reduces the frame height to increase the glass area. Enjoy patio doors that slide smoothly on dual ball-bearing rollers with self-contained leveling adjusters. A reach-out lock system provides increased security and weathertightness.

PROTECTED

Rigid wood panels and frame are covered with a vinyl sheath that maintains an attractive appearance while minimizing maintenance.

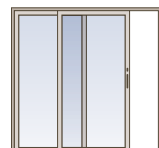

Two Panel

EXPRESS YOUR STYLE Color Options³

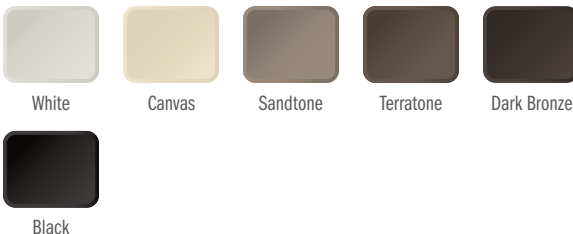

Interior and exterior colors match.



Perma-Shield Gliding Patio Door / White Interior



Perma-Shield Gliding Patio Door / Terratone Interior



Perma-Shield Gliding Patio Door / White Interior

PATIO DOOR HARDWARE OPTIONS

PLENTY OF OPTIONS FOR YOUR PERSONAL STYLE.

								HINGED
Encino®	Yuma®	Newbury®	Whitmore®	Covington™	Anvers®	Albany	Tribeca®	
								GLIDING
								FINISHES
Distressed Bronze ¹¹	Distressed Nickel	Polished Chrome	Antique Brass ¹⁰	Bright Brass ¹⁰	Satin Nickel ¹⁰	Black	White	
Also Available	Also Available	Also Available	Also Available	Also Available	Also Available	Also Available	Also Available	
Distressed Nickel	Distressed Bronze ¹¹	Brushed Chrome	Satin Nickel ¹⁰	Satin Nickel ¹⁰	Antique Brass ¹⁰	Bright Brass ¹⁰	White	Stone
		Bright Brass ¹⁰	Antique Brass ¹⁰	Bright Brass ¹⁰	Oil Rubbed Bronze ¹¹	Oil Rubbed Bronze ¹¹	Stone	Gold Dust
		Oil Rubbed Bronze ¹¹	Oil Rubbed Bronze ¹¹					

Select one hardware style for the inside and another for the outside



Yuma Hinged Door Handle / Distressed Bronze Finish



Newbury Hinged Door Handle / Satin Nickel and Oil Rubbed Bronze Finishes

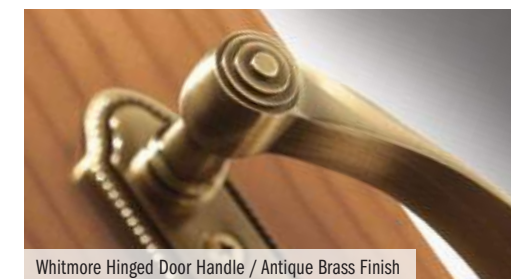

Whitmore Hinged Door Handle / Antique Brass Finish



Anvers Gliding Door Handle / Satin Nickel Finish

PATIO DOOR ENGINEERING

A COMBINATION OF DETAILS
NOT FOUND ELSEWHERE.

FUNCTIONAL REQUIREMENTS:
- Door operation

ENGINEERING SOLUTION:
- Ball bearing track rollers

HOMEOWNER BENEFIT:

A gliding door that glides reliably and has superior weathertightness.

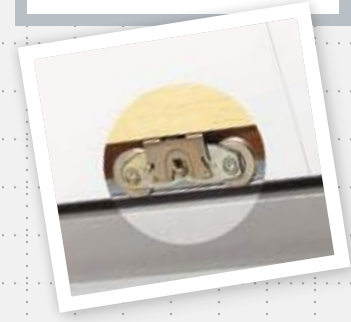

FUNCTIONAL REQUIREMENTS:
- Reduce water infiltration during extreme weather events

ENGINEERING SOLUTION:
- Contain and drain sill (Frenchwood® Patio Doors only)

HOMEOWNER BENEFIT:

Designed to contain excess water and drain away from the house.



Frenchwood® Gliding Patio Door
Pine Interior
Newbury® Bright Brass Hardware

FUNCTIONAL REQUIREMENTS:
- "Performance Grade LC (Light Commercial)" water and air leakage resistance

ENGINEERING SOLUTION:
- Weatherstrip interlock system

HOMEOWNER BENEFIT:

Patio doors with a higher performance grade than other residential patio doors.



FUNCTIONAL REQUIREMENTS:
- Strengthen corner joints
- Increase patio door beauty

ENGINEERING SOLUTION:
- Mortise-and-tenon corner joint

HOMEOWNER BENEFIT:

Unique corner key design increases structural integrity and beauty.

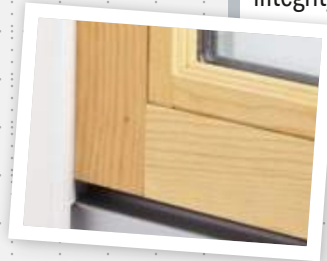

PATIO DOOR OPTIONS

CREATE CURB APPEAL OR ARCHITECTURALLY ACCURATE STYLING.

Grilles

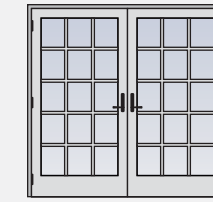

Colonial

Specified number of squares per sash.

Frenchwood® hinged patio door shown

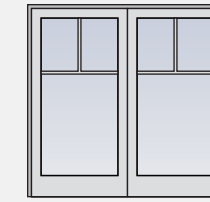

Tall Fractional

Specified number of vertical bars meet a horizontal bar.

Frenchwood gliding patio door shown

EXPRESS YOUR STYLE

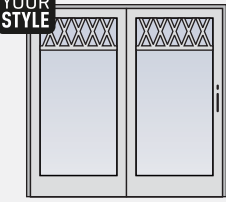

Custom

Create a new pattern or revive one from the past.

Frenchwood gliding patio door shown

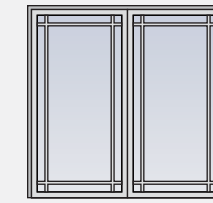

Prairie

Two vertical and two horizontal bars per sash to form 4-inch corner squares.

Narroline® gliding patio door shown

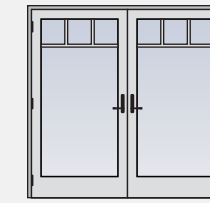

Short Fractional

Specified number of vertical bars meet a horizontal bar.

Frenchwood hinged patio door shown



More

Ask your design consultant for more grille options.

Frenchwood hinged patio door shown

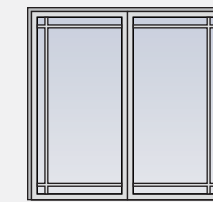

Modified Prairie

Two horizontal bars and one vertical bar per sash.

Narroline gliding patio door shown

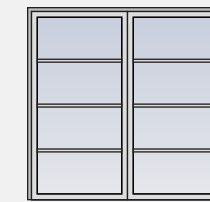

Equal Light

Specified number of horizontal bars, equal distance apart.

Narroline gliding patio door shown

Insect Screens

Hinged, double-hinged, gliding, and retractable insect screens are options for your Andersen® patio doors and are available in an exterior color to match your patio door.



Hinged Insect Screen

Compatible with Frenchwood hinged patio doors (one panel)



Double-Hinged Insect Screen

Compatible with Frenchwood hinged patio doors (two panel)

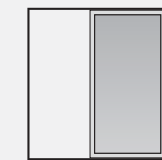

Gliding Insect Screen

Compatible with Frenchwood hinged patio doors (two panel), all gliding patio doors

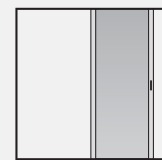

Retractable Insect Screen

Compatible with Frenchwood hinged outswing patio doors,¹⁴ all gliding patio doors

Blinds Between-the-Glass



Convenient blinds between-the-glass are now available on select doors.

White blinds are located between the panes of insulated glass, protected from dust and damage.

Cordless design to easily raise, lower, or tilt blinds for control of light and privacy.

Glass is easy to clean without the need to move the blinds.

Available on doors with white exteriors and unfinished pine or prefinished white interiors.

Security

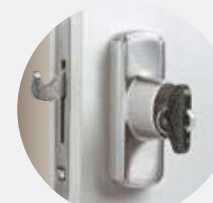

Exterior Keyed Locks

Compatible with all patio doors



Auxiliary Foot Lock

Offers an extra measure of security when the door is in locked position. It can also hold the operating panel partially open.

Compatible with gliding patio doors only

Patio Door Security

STANDARD FEATURE

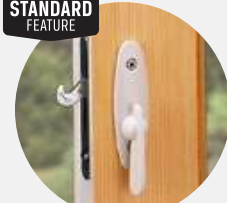

Gliding Patio Door Locks

The unique Andersen® reach-out locking system pulls the door panel snugly into the jamb for weathertightness and enhanced security.

STANDARD FEATURE



Hinged Patio Door Locks

Five-point locking system improves energy efficiency and offers an increased level of security. Also available is an optional handle extension kit, which creates additional clearance for interior blinds and shades.

Enhanced Comfort

At Renewal by Andersen, we'll help you sort through the details of glass heating and cooling performance, visible light transmittance, and ultraviolet (UV) protection to pinpoint the right window glass for you. Our windows take advantage of the newest technologies to help lower energy costs and keep your family comfortable.

Enhanced Triple Pane

Enhanced comfort, enhanced efficiency, enhanced design. An extra pane of glass helps keep the indoor temperature in and the outdoor temperature out, making this our most energy-efficient glass option.

Enhanced Triple Pane
An extra pane of glass helps keep more heat in and cold air out, making this our most energy-efficient glass option best suited for colder climates.

Enhanced Triple Pane with SmartSun™ Glass
Has the added benefits of our Low-E4 SmartSun glass.

Select Renewal by Andersen windows® with Enhanced Triple Pane glass have been designated as one of the Most Efficient ENERGY STAR® certified products in 2021.



Patterns

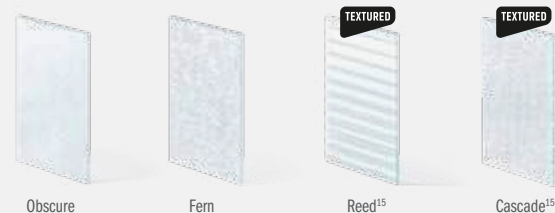

High-Performance Glass



Low-E4® SmartSun™ Glass
SmartSun glass meets our highest standards in cool and hot weather performance. SmartSun glass blocks 95% of harsh UV rays that can damage drapes, artwork, and furniture.

Low-E4® Glass
Perfect where both heating and cooling costs are a concern, our Low-E4 glass helps keeps your home warmer in winter, cooler in summer, and blocks 84% of harmful UV rays.

Low-E4® SmartSun™ Glass with HeatLock® Technology
You get all of the benefits of our Low-E4 SmartSun glass plus an energy-saving glass coating that helps your living space feel warmer and more comfortable.

Low-E4® Sun Glass
For hot, dry climates with little shade or cloud cover, our Low-E4 Sun Glass utilizes a subtle tint to help block out heat from the sun, reducing cooling costs.

Enhanced Triple Pane

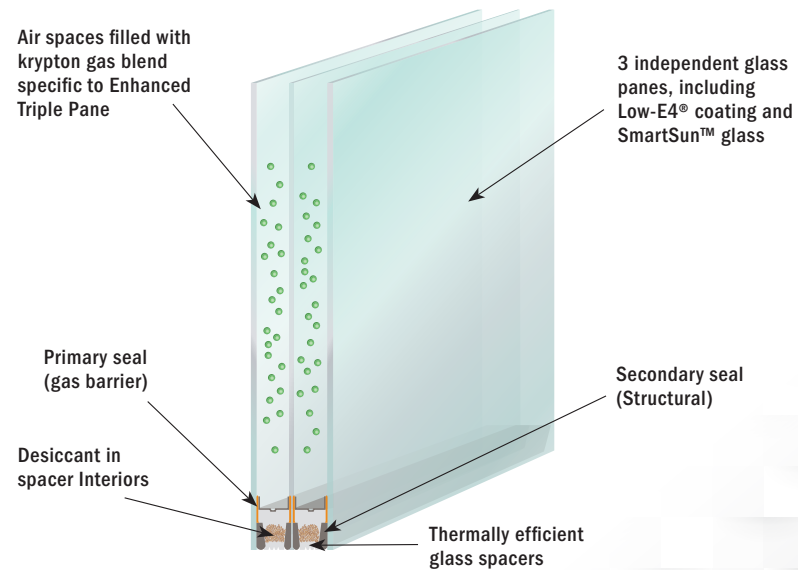

Strength

Our tempered glass option is heat-treated to be at least four times stronger than standard annealed glass.

Your Design:

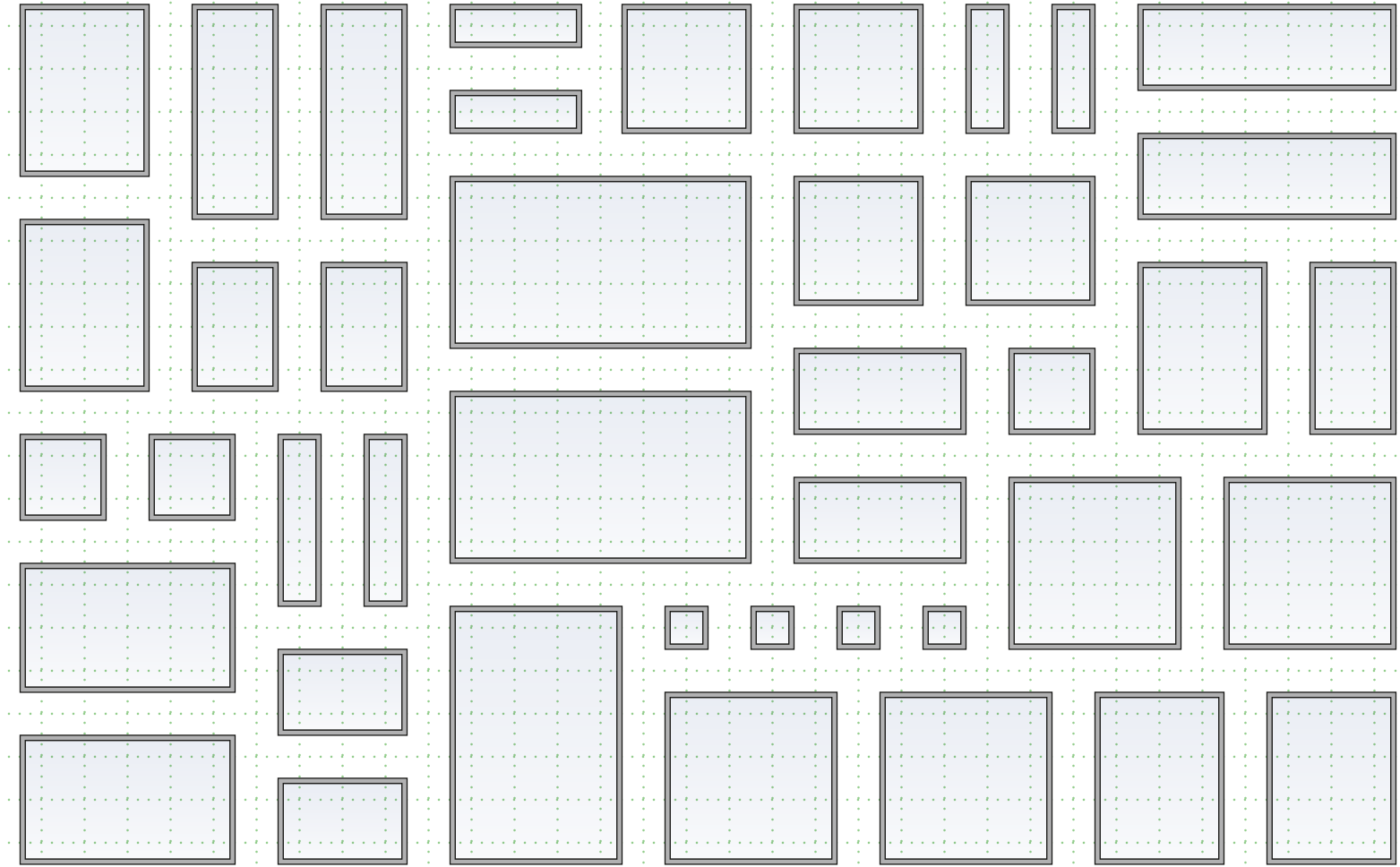

Your Window Design Consultant will help you at every step of your project by...

- ...listening to your needs
- ...providing solutions that may add value to your home
- ...helping you determine the best style for your home
- ...communicating your project's progress
- ...saving you time and stress





Industry-Leading Warranty

We stand behind our products and services.

The Renewal by Andersen® limited warranty is one of the strongest you'll find on any window or door, at any price. It's non-prorated and fully transferable. Every window we make is labeled with our toll-free number, should you have any issues with your window. It's one more way that you know we're here for you now and well into the future.

Your satisfaction is our measure of success.

Nationwide, a homeowner satisfaction survey is sent to each home after every project we do. Customer satisfaction is a primary component of the Renewal by Andersen culture. Your feedback has proven to be an invaluable asset as we continue our never-ending mission to improve our products and services.

Call us today.

We would love to help you with your replacement project.



Window and Door Replacement from a Company You Can Trust™

Don't take our word for it. Renewal by Andersen has long been committed to environmentally responsible products and manufacturing methods. Our efforts have been recorded and recognized by leading organizations with some of the most rigorous standards in the United States.



RENEWAL
by **ANDERSEN**
FULL-SERVICE WINDOW & DOOR REPLACEMENT

[RENEWALBYANDERSEN.COM](https://renewalbyandersen.com)

†It is the only warranty among top selling window companies that meets all of the following requirements: easy to understand terms, unrestricted transferability, installation coverage, labor coverage, geographically unrestricted, coverage for exterior color, insect screens and hardware, and no maintenance requirement. Visit renewalbyandersen.com/nationsbest for details. Models used in photographs. License number available upon request. "Andersen," "Renewal by Andersen" and the Renewal by Andersen logo are registered trademarks of Andersen Corporation. For J.D. Power 2020 award information, visit jdpower.com/awards. "ENERGY STAR" is a registered trademark of the U.S. Environmental Protection Agency. All other marks where denoted are marks of Andersen Corporation. © 2021 Andersen Corporation. All rights reserved. RBA12619

DG Double-Hung Window—General

- Advantages and Applications 12-2
- Exploded View 12-3
- Standard Features 12-5
- Options 12-6
- Screen and Glass Options 12-9
- Grille Options 12-10
- Trim Options 12-12
- Color Combination Chart 12-14
- Min/Max Sizes 12-15
- Possible Limited Sash Travel 12-19
- Potential Egress Sizes 12-20
- Check Rail and Sash Heights 12-21

Insert Application for DG Configurations 12-22

- Vertical Sections..... 12-24

Full Frame Application for DG Configurations 12-25

- Vertical Section 12-26

DG Double-Hung Window and Related Patents..... 12-27

DG DOUBLE-HUNG WINDOW

ADVANTAGES AND APPLICATIONS

A DG Double-Hung window consists of two vertically sliding sash in a single frame. Each sash is counter-balanced by a uniquely configured block-and-tackle balance mounted into the sides of each sash. Each sash may be tilted in for easy cleaning by actuating the hidden tilt-latch mechanisms. When locked, a cam-type sash lock securely closes the upper and lower sash and seats them snugly into their weather-stripping systems. An insect screen may be installed into the outside track of the window frame.

Renewal
by Andersen®
WINDOW REPLACEMENT an Andersen Company



*DG Double-Hung
Replacement Windows*

“Perma-Shield” and all other marks where denoted are trademarks of Andersen Corporation

ADVANTAGES

- Both sash can be operated for ventilation at the top and the bottom of the window.
- Both sash tilt in for safe and easy cleaning.
- Patented lower sash tilt-latch cassette and interlock assembly offers safe and secure sash tilting while providing maximum security and structural performance.
- Patented upper sash tilt-latch cassette offers single point activation for safe and easy tilting for cleaning.
- Patented Fibrex® Material is stronger than vinyl, providing greater durability.
- Patented Fibrex® Material with low maintenance Perma-Shield® capping gives a rich, low luster finish to sash and frame, similar to painted wood.
- Surfaces on the sash and frame are designed with smooth radii which are visually pleasing and easier to clean.
- Mortise-and-tenon appearance on both the interior AND exterior sash corners provides a traditional, hand-crafted look.
- Sash and frame corners are joined utilizing precision molded corner keys, EPDM (ethylene propylene diene monomer) gaskets and injected hot melt adhesive for superior strength, durability and weather tightness.
- Weatherstrip system is designed utilizing cutting edge materials providing superior weather tightness and durability while allowing easy sash operation.
- Sash are counter-balanced by coil-spring powered block-and-tackle balance mounted into the sides of each sash. Each balance is uniquely configured and engineered for that exact sash size and weight which minimizes operating force.

APPLICATIONS

- Excellent choice for homes and condominiums where traditional styling is important; appropriate for many restoration projects.
- Suitable in areas facing walkways, decks and other traffic areas because sash do not project outward.
- Convenient in areas where the sash need to be cleaned from the interior.
- Visually compatible with other Renewal by Andersen® products.

EXPLODED VIEW

DG DOUBLE-HUNG WINDOW

DG DOUBLE HUNG COMPONENTS

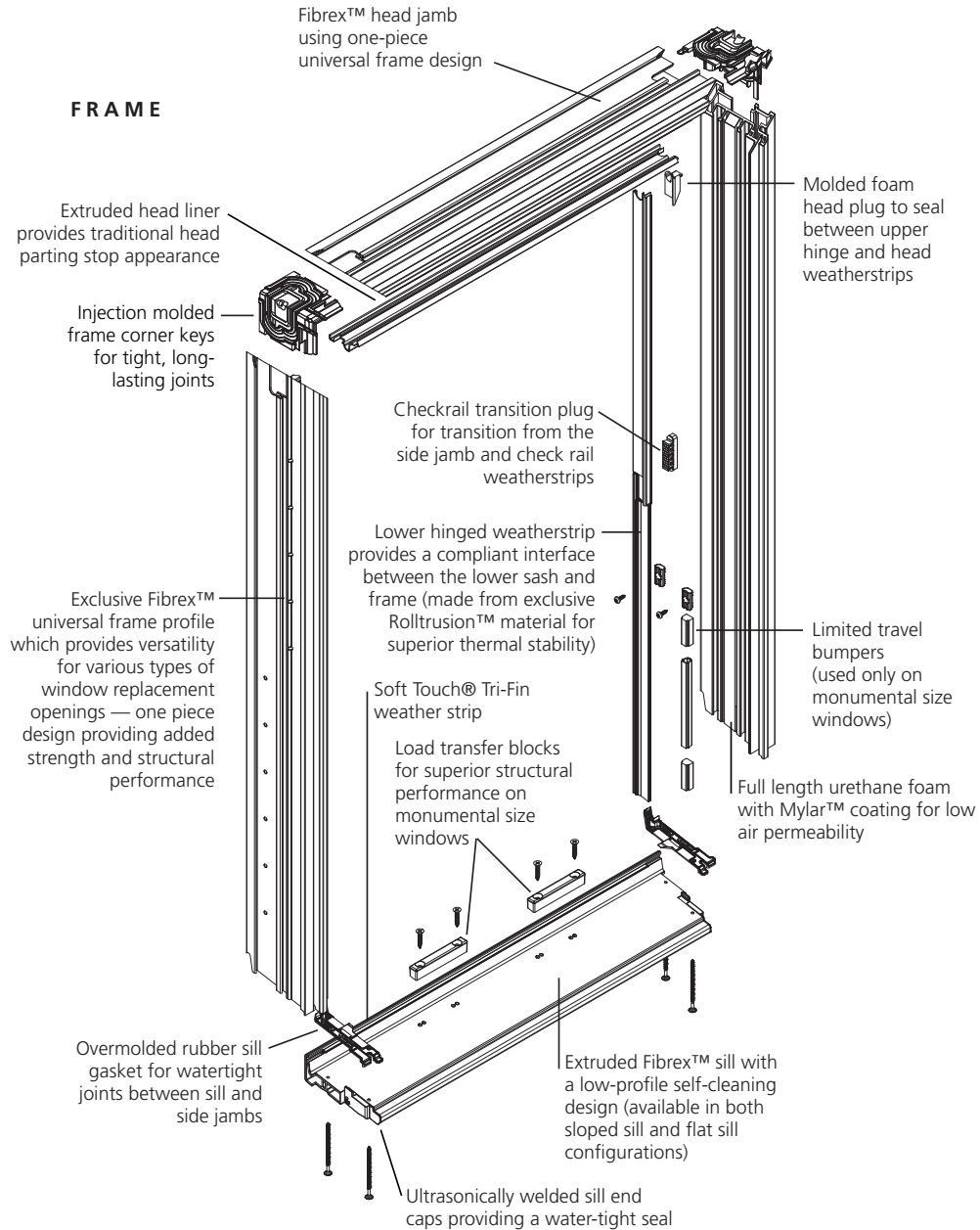

EXPLODED VIEW

DG DOUBLE-HUNG WINDOW

DG DOUBLE HUNG COMPONENTS CONT.

Top rail weatherstrip provides air-tight performance using automotive-grade EPDM foam material; mechanically fastened at each end to eliminate shrink-back

Fibrex™ Extrusion with precision mortise-and tenon joinery

UPPER SASH

Interior sash hoop for a classic glass lip

Concealed sash corner keys provide tight, long-lasting performance

High-Performance (HP) glass

Metal keeper for maximum security

Exterior sash hoop Fibrex® extrusion with precision end fabrication and traditional mortise-and-tenon joinery appearance

Custom-sized block and tackle balancers optimized on 1 lbs/1" increments for smooth opening and closing

Soft Touch® Tri-Fin weatherstrip interfaces with upper sash to provide full length, air-tight performance

Full-length upper sash interlock made of exclusive Rolltrusion™ material to provide superior stiffness, dimensional stability, and air-tight performance

Interior sash hoop with either Traditional or Modern check rail design

LOWER SASH

Interlock transition block for dual weatherstrip at the check rail

Custom sized block and tackle balancers optimized on 1 lbs/1" increments for smooth opening and closing

Fibrex™ Extrusion with precision mortise-and-tenon joinery

Concealed sash corner keys provide tight, long-lasting performance

High-Performance (HP) glass

Soft-Touch® Tri-Fin reveal weatherstrip to provide full perimeter dual weatherstrip

Bottom weatherstrip to provide air-tight performance using automotive grade EPDM foam material; mechanically fastened at each end to eliminate shrink-back

STANDARD FEATURES

DG DOUBLE-HUNG WINDOW



A Flat Sill Base Frame Double-Hung window corner section is shown here, though **standard features are the same as for all** Double-Hung windows.

Described below are features that contribute to the DG Double-Hung window's low maintenance, energy efficiency, ease of operation, and pleasing appearance.

- **Frame** – Made of rigid Fibrex® material a unique structural composite of wood fibers and a special thermoplastic polymer. Developed by Andersen®, Fibrex material combines the strength and stability of wood with the low-maintenance features of our time-tested Perma-Shield® cladding.
- **Sash** – Constructed of Fibrex material. Corner keys provide durable, watertight corners. The mortise and tenon joinery complements the frame. A high-performance silicone sealant provides a watertight seal between the glass and sash.
- **Glazing** – High-Performance™ LoE⁴* glass with an inert, energy-efficient gas, is standard for every window. See Options on page 12-9 for other glass choices.

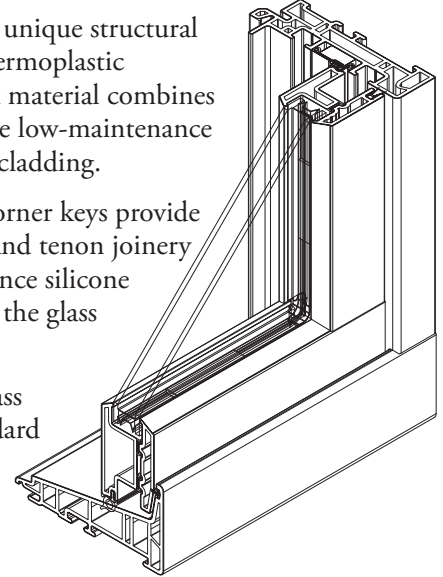

*LoE⁴ is a registered trademark of Cardinal IG Company.

- **Glass spacer** – The patented low-conductivity spacer is made of stainless steel and resists heat transfer four to five times better than aluminum spacers used by many other manufacturers. Additionally, the stainless steel spacer is more durable than other spacers.
- **Removable protective film** – Packaging features a clear protective film that is factory applied to both the interior and exterior glass surfaces to help protect the glass from shipping and installation damage.
- **Weatherstrip** – A diverse system consisting of automotive grade EPDM foam filled bulbs, Soft Touch™ Tri-Fin piles and constant-force reinforced low friction polymer components provide multiple layers of protection from the elements.

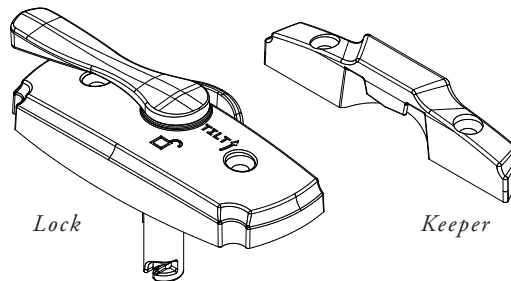

- **Sash Lock and Keeper** – The lock and keeper components are manufactured from durable zinc die cast material providing maximum security. When actuated, the lock cam engages easily into the keeper and drives the sash into the head and sill weather-strips resulting in a tight barrier between the sash and frame.
- **Tilt-Mechanisms** – Patented sash tilting assemblies provide innovative, safe and easy tilting. The upper sash tilt-latch cassette offers single point activation for safe and easy tilting for cleaning. The lower sash tilt-latch cassette and interlock assembly, which is actuated by the lock mechanism, offers safe and secure sash tilting while providing maximum security and structural performance.

OPTIONS

DG DOUBLE-HUNG WINDOW

The following options are available for all Renewal by Andersen® DG Double-Hung windows:

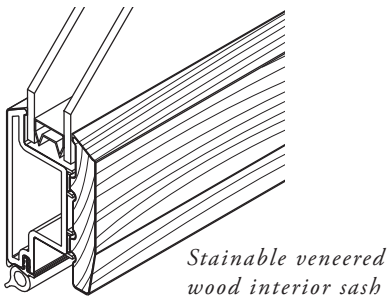
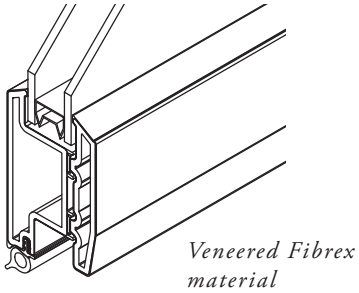

- **Dual-Colors and Stainable veneered wood Interior** – Dual-color windows are available that have different interior and exterior colors. Stainable wood interior veneers are also available in oak, maple, and engineered pine. The Double-Hung Window Component Color Combination Chart on page 12-14 shows available color combinations and the default color of individual components for these combinations. Alternative component (e.g., insect screens, grilles, hardware, side jams) color combinations are available upon request.

Painting and staining guidelines for Fibrex® material and stainable wood interiors are available in this manual, the *Product Installation Manual* and in the *Care and Maintenance Guide*.

- **Sill Options** – The DG double hung is available with two different sill configurations. A 12° Sloped Sill for use in insert applications where the existing window sill is angled to the exterior and a Flat Sill for use in various other applications.

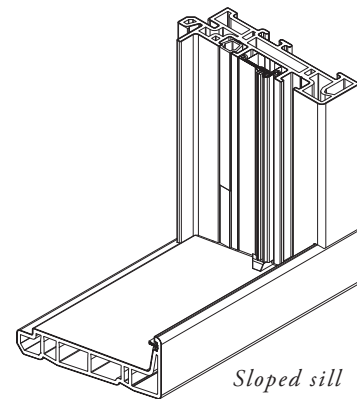
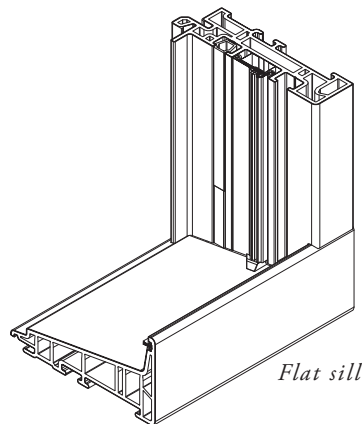

OPTIONS

DG DOUBLE-HUNG WINDOW

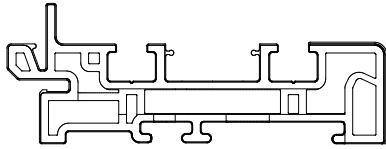

Base Frame

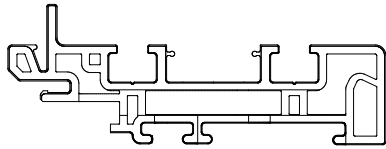

Insert Frame

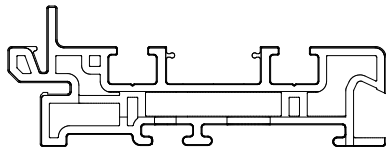

EJ Frame

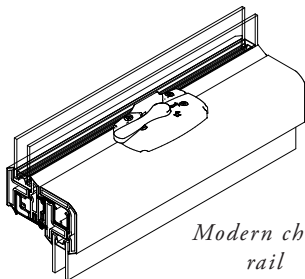

Modern check rail

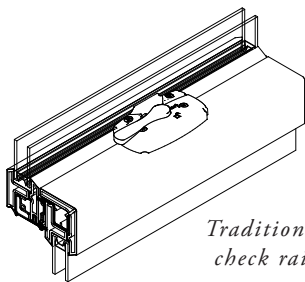

Traditional check rail

- **Frame Options** – The DG Double-Hung is available with 3 different Universal Frame options.
 - A Base Frame, which consists of a full outer frame nose and accessory kerf that is compatible with the Universal Picture Window (PWU), and a CLOSED interior frame profile. The Base Frame is available with both the Sloped Sill and Flat Sill.
 - An Insert Frame, which consists of a notched outer frame member with a kerf ready to nest itself into an exterior sash stop of an existing 3-1/4” jamb pocket, and a CLOSED interior frame profile. The Insert Frame is available with both the Sloped Sill and Flat Sill.
 - An EJ Frame, which consists of a full outer frame nose and accessory kerf that is compatible with the Universal Picture Window (PWU), and an OPEN interior frame profile factory prepared to receive an Extension Jamb. The EJ Frame is ONLY available with the Flat Sill.
- **Structural Performance Upgrade** – The Double-Hung (DG) window is available in a structural Design Pressure (DP) upgrade to +/-DP50. Size restrictions apply.
- **Modern Check Rail** – The check rail is available in a contemporary version where the innermost 1/2” of the top of the check rail curves gently to the interior face off the window.
- **Traditional Check Rail** – The check rail is available in a squared version where the top of the sash remains flat to the face of the window.
- **TruScene® Insect Screen** – Micro-fine stainless steel mesh (25 x 25 per inch mesh) that provides over 50% more clarity than standard Andersen insect screens. (See following chart for size restrictions.)
- **Universal Frame Profile** – Can be used in either insert OR full frame applications.

OPTIONS, cont.

DG DOUBLE-HUNG WINDOW



When finger lifts are desired, order the window with **no** lifts. Finger lifts are then installed in the field after the window installation.

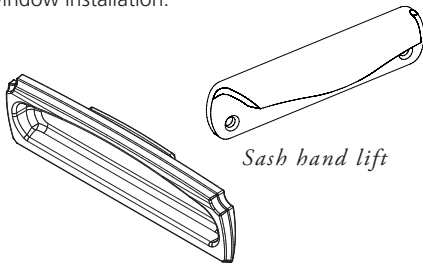

Sash hand lift

Recessed lift handle

Painted Metal Hardware

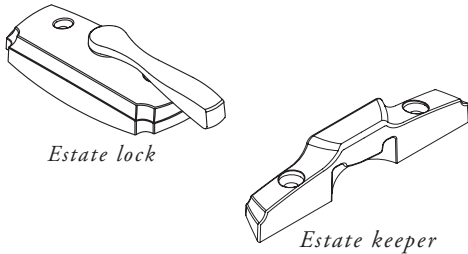

Estate lock

Estate keeper

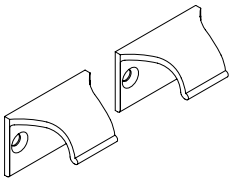

*Estate finger lifts
(see notice above)*

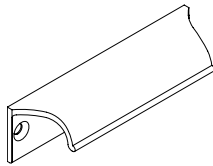

Estate™ hand lift

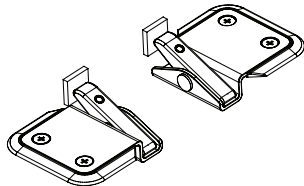

Opening control device

- **Glass Breather Tubes** – Breather tubes are available for glass intended for high-altitude installations. It is important to note that breather tubes will decrease the thermal performance of the unit. Refer to the Technical Data (Section 8) in this Spec and Tech Manual for altitude specifics.
- **Additional Sash Lock** – All standard performance DG units greater than 40" wide will be manufactured with two locks. All performance upgrade DG units greater than 36" wide will be manufactured with two locks. All other units will be manufactured with one lock. If an additional lock is desired on the single lock units, it can be ordered with a second lock. However, DG units less than 23" can NOT be ordered with two locks.
- **Recessed Lift Handle** – A recessed lift handle factory applied in the tall-bottom-rail is available in all of the interior hardware colors and finishes. One OR two recessed sash lifts may be specified; however units less than 23" wide are limited to one recessed sash lift.
- **Hand Lift** – A lift is available in all of the interior hardware colors and finishes with factory drilled mounting holes on the tall-bottom-rail. One OR two hand lifts may be specified; however units less than 23" wide are limited to one factory drilled hand lift.
- **Estate™ Finish Hardware** – Estate finish hardware is available for all operating windows and is available in bright brass, antique brass, satin nickel, distressed nickel, brushed chrome, polished chrome, distressed bronze, oil-rubbed bronze and dark bronze. Hardware in each of the finishes is electroplated and/or modified to obtain the desired look. The Estate face-mounted hardware components for DG Double-Hung windows are listed below:
 - **Lock and Keeper** – The zinc die cast, plated lock and keeper provide elegant Estate styling that beautifully complements not only the window, but matches any Estate hardware found on Andersen® patio doors.
 - **Finger Lifts** – These smaller, more traditional looking lifts provide a different aesthetic option for a grasp to operate the window. These lifts are typically used in pairs and are available in all our colors and finishes.
 - **Opening Control Device** – Field-applied device restricts sash opening to 4 inches. This device will allow full sash opening when disengaged and will re-engage when sash is closed.

OPTIONS, cont.

DG DOUBLE-HUNG WINDOW

TRUSCENE® DG AVAILABILITY RESTRICTIONS

DG Double-Hung Window	Half Insect Screen	All sash ratios	All sizes available, no restrictions
DG Double-Hung Window	Full Insect Screen	All sash ratios	Restrictions All heights available for unit widths less than or equal to 50-1/4". All widths available for unit heights less than or equal to 48-5/8".

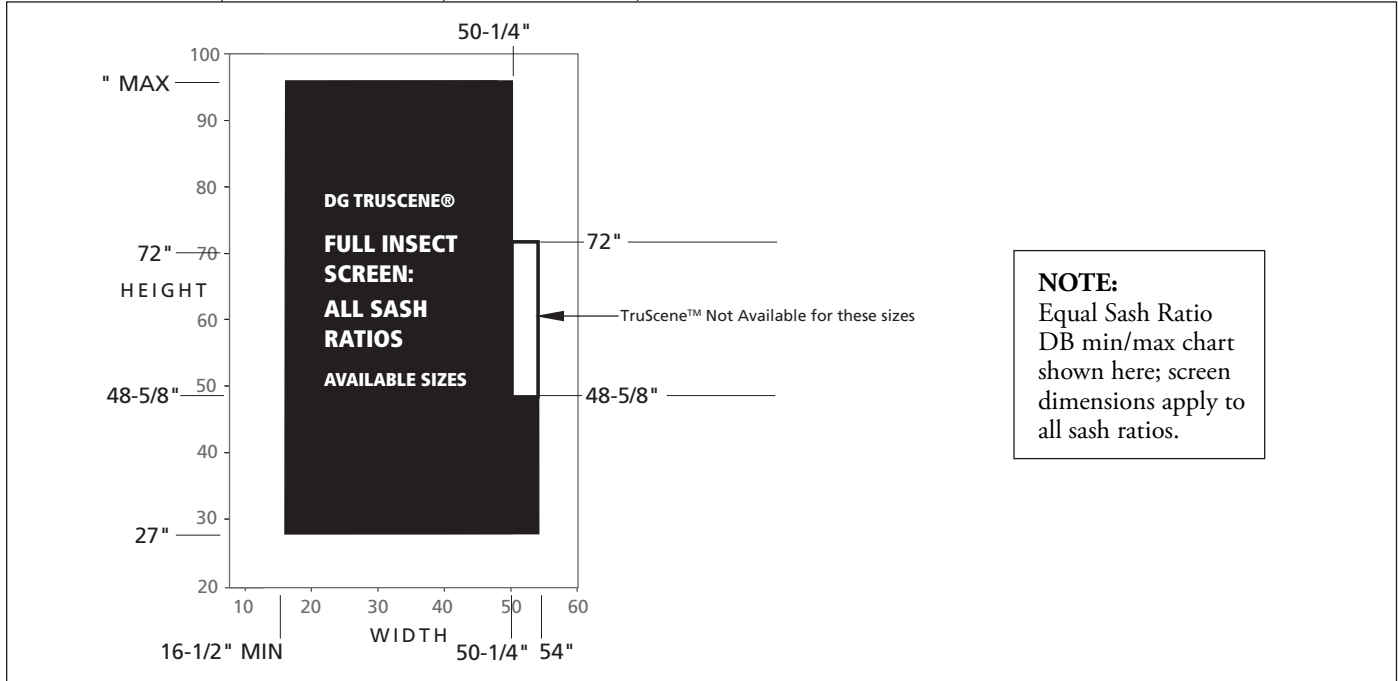

Glass Options

- High Performance® Low-E4 SmartSun™ with Heatlock™ (no pattern)
- High Performance® Low-E4 SmartSun™ tinted
- High Performance® Low-E4 SmartSun™ (no pattern)
- High Performance® Low-E4 (no pattern)
- Obscure
- Reed
- Cascade
- Fern

- **Aluminum Insect Screen Cloth** – Durable aluminum screen cloth (18 x 16 per inch mesh) in a glare-resistant charcoal gray.
- **Half Insect Screen** – A half insect screen is available that only covers the lower sash. The half screen does not impede the operation of the upper sash.
- **Decorative Glass Patterns** – Standard windows have no textured glass pattern whatsoever. Optional textured patterns are as follows:
 - Obscure
 - Reed
 - Cascade
 - Fern
- **Glass Coating** – High-Performance™ Low-E4™ coating is standard with all windows. Optional glazings are as follows:
 - Clear (no coating)
 - SmartSun™
 - High-Performance Low-E4 tinted coating
 - High Performance® Low-E4 with Heatlock™

* High Performance® Low-E4 SmartSun™ with Heatlock™ not available with decorative glass patterns
- **Tempered Glass** – Tempering is an option for all available glass options. Untempered glass is standard.

OPTIONS, cont.

DG DOUBLE-HUNG WINDOW

Available Grille Types

Three grille types are available. The interior and exterior sides of the grilles are color-coordinated with each side of the window frame. Consult the color combination charts in each window product section for detailed color information.

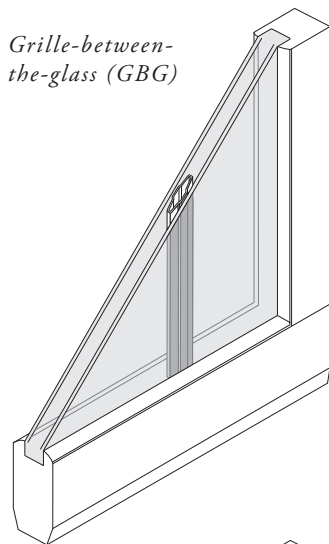

Grille-between-the-glass (GBG)

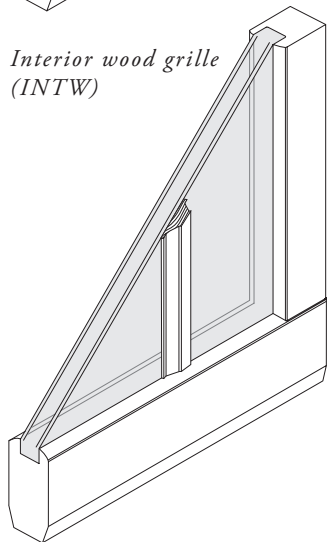

Interior wood grille (INTW)

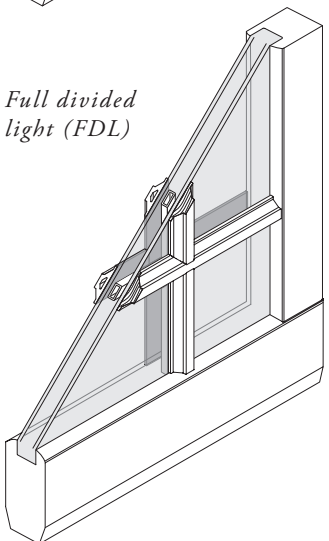

Full divided light (FDL)

Grille-Between-the-Glass (GBG)

Sculpted aluminum grille members are manufactured between the glass panes, and are available in two widths. Enamel finish replicates interior and exterior face of window. If wood interior, interior facing surface will be gray.

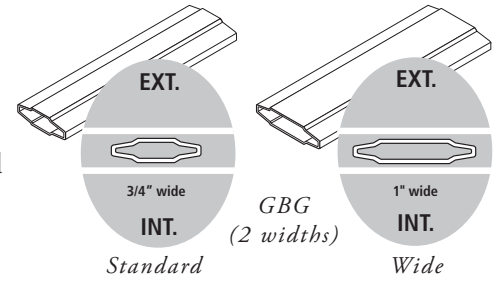

Interior Wood Grille (INTW)

With the option of hardwood maple or oak, these grilles snap into clips placed around the interior side of the sash and may be removed to clean the glass. These high-definition interior wood grilles are available in two different widths.

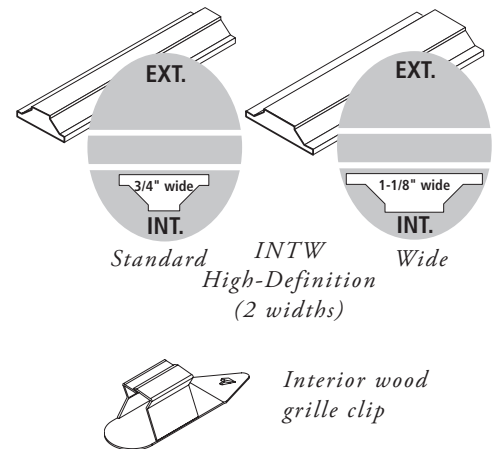

Full Divided Light (FDL) Grille

FDL grilles provide the classic look of a true divided light window. The high-definition exterior grille is made from Fibrex® material and is available in two different widths. Between the glass panes, an aluminum spacer stands slightly away from each pane to maintain thermal performance. The high-definition interior wood grille is available in hardwood, maple or oak and in two different widths, and may be permanently applied or removable.

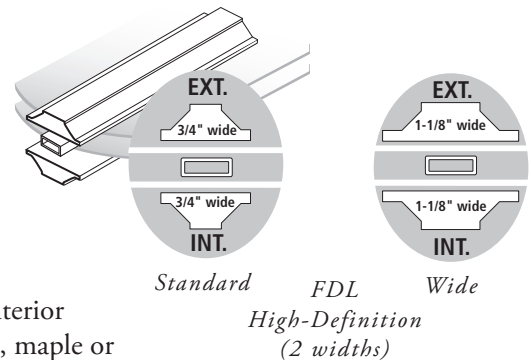

OPTIONS, cont.

DG DOUBLE-HUNG WINDOW

- Available Grille Patterns – Grille pattern options include colonial, prairie, and modified prairie.

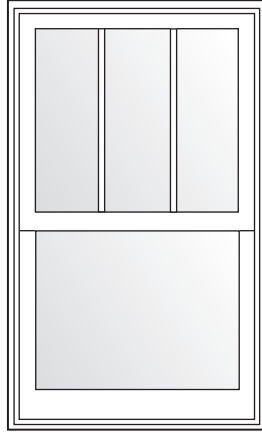
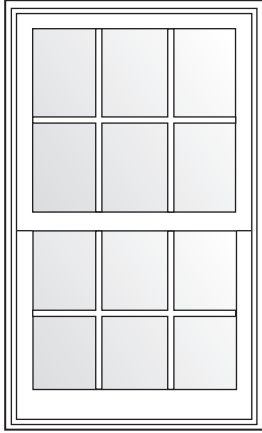

COLONIAL

Refer to colonial pattern grilles by pattern name and “grille lites wide by grille lites high” for each sash. For the examples shown, the left window would be “colonial pattern, 3 by 2, upper and lower sash”. For the example to the right, “colonial pattern, 3 by 1 on the upper sash, no grille on the lower sash”.

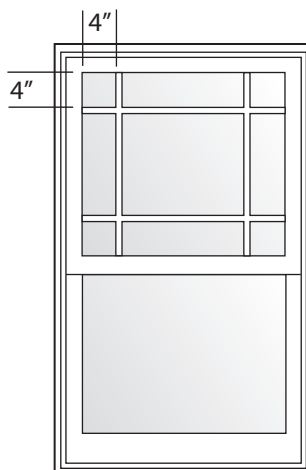
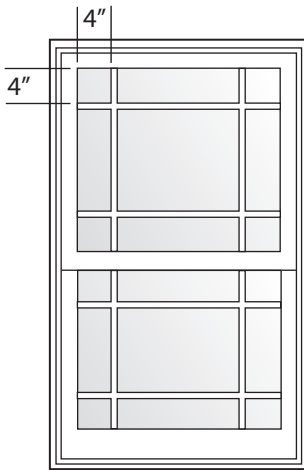

PRAIRIE

Regardless of sash size, all prairie grilles intersect to form 4” squares of visible glass in the corners of the sash. Prairie grilles are available on one or both sash.

The prairie grille pattern is not available on DG Double-Hung windows narrower than 20”.

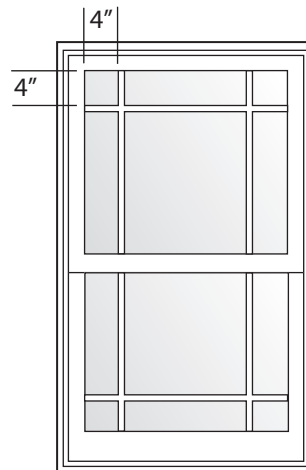

MODIFIED PRAIRIE

Regardless of sash size, all modified prairie grilles intersect to form 4” squares of visible glass. Modified prairie grilles are available for one or both sash.

The modified prairie grille pattern is not available on DG Double-Hung windows narrower than 20”.

OPTIONS, cont.DG DOUBLE-HUNG WINDOW

- **Exterior Brickmould** – Fibrex® Material Brickmould is available as an exterior trim option. It is available in two widths (2" and 3") and two different configurations (traditional and picture-frame). It is available factory applied or as components for field fabrication and application.
- **Chamfered Edge Overfit** – Fibrex® Material decorative overfit flange is available as an exterior trim option. It is available factory applied or as components for field fabrication and application.

OPTIONS, cont.

DG DOUBLE-HUNG WINDOW

Installation Flexibility – The frame can accommodate the following installation accessories. (Please see the Technical Measure Guide for detailed dimensions.)

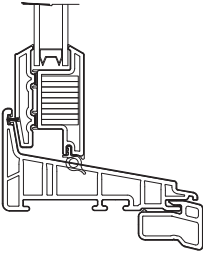
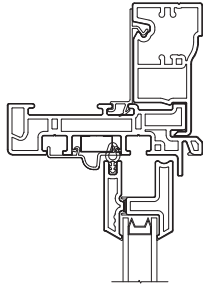

3" Traditional Brick Mould

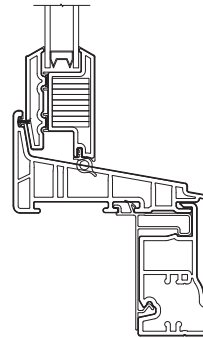
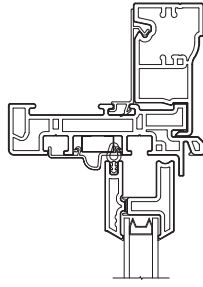

3" Picture Frame Brick Mould

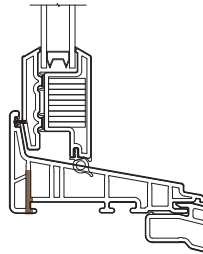
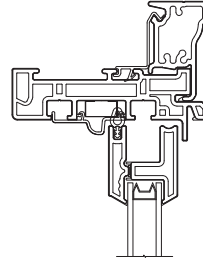

2" Traditional Brick Mould

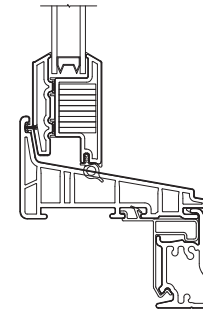
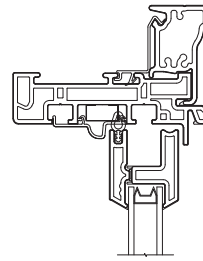

2" Picture Frame Brick Mould

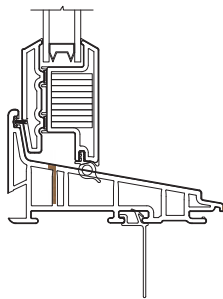
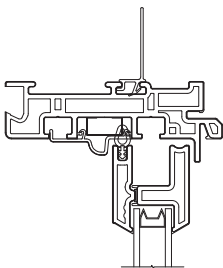

Nailing Flange

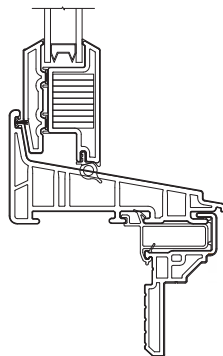
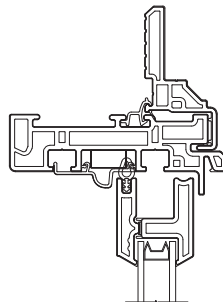

Chamfered Edge Overfit

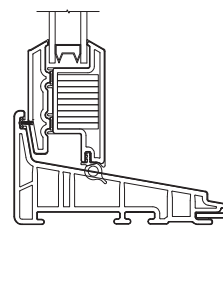
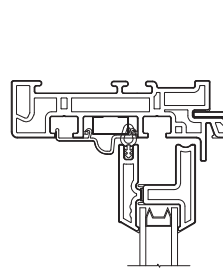

L-Trim

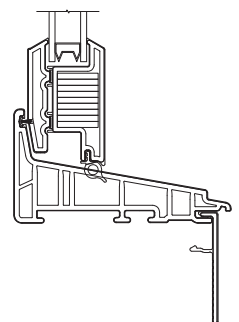
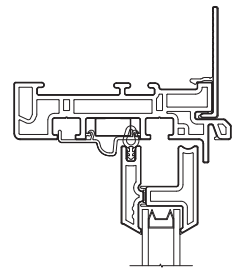

F-Trim

WINDOW COMPONENT COLOR COMBINATION CHART

DG DOUBLE-HUNG WINDOW

Window Color	Components		Grilles Between Glass		Interior Wood & Full Divided Light Grilles		Headliner		Side Jamb Liner Weather-Strip		Interior Sash Track		Sill		Upper Interlock		Sill Gasket			
	Exterior	Interior	Hardware	Exterior	Interior	Exterior	Interior	Exterior	Interior	Lower (exterior)	Upper (interior)	Interior	Exterior	Interior	Exterior	Exterior	Interior	Exterior		
Single Colors	White	White	White	White	White	White	White	White	White	White	White	White	White	White	White	White	White	Black	Black	
	Canvas	Canvas	Canvas	Canvas	Canvas	Canvas	Canvas	Canvas	Canvas	White	Canvas	Canvas	Canvas	Canvas	Canvas	Canvas	Canvas	White	White	
	Sandstone	Sandstone	Stone	Sandstone	Sandstone	Sandstone	Sandstone	Sandstone	Sandstone	White	Sandstone	Sandstone	Sandstone	Sandstone	Sandstone	Sandstone	Sandstone	Black	Black	
	Terratone	Terratone	Stone	Terratone	Terratone	Terratone	Terratone	Terratone	Terratone	White	Terratone	Terratone	Terratone	Terratone	Terratone	Terratone	Terratone	Black	Black	
	Dark Bronze	Dark Bronze*	Dark Bronze	Dark Bronze	Dark Bronze	Dark Bronze	Dark Bronze	Dark Bronze	Dark Bronze*	Dark Bronze*	Dark Bronze*	Dark Bronze	Dark Bronze	Dark Bronze	Dark Bronze	Dark Bronze	Dark Bronze	Black	Black	
	Black	Black*	Black	Black	Black	Black	Black	Black	Black*	Black	Black*	Black	Black	Black	Black	Black	Black	Black	Black	Black
	Canvas	White	White	Canvas	White	Canvas	White	White	White	White	White	White	White	White	White	White	White	Black	Black	Black
	Sandstone	Sandstone	Terratone	Sandstone	Sandstone	Sandstone	Sandstone	White	White	White	White	White	White	White	White	White	White	Black	Black	Black
	Dark Bronze	Dark Bronze	Dark Bronze	Dark Bronze	Dark Bronze	Dark Bronze	Dark Bronze	White	White	White	White	White	White	White	White	White	White	Black	Black	Black
	Black	Black	Black	Black	Black	Black	Black	White	White	White	White	White	White	White	White	White	White	Black	Black	Black
Cocoa Bean	Cocoa Bean	Forest Green	Cocoa Bean	Cocoa Bean	Cocoa Bean	Cocoa Bean	White	White	White	White	White	White	White	White	White	White	Black	Black	Black	
Forest Green	Forest Green*	Forest Green	Forest Green	Forest Green	Forest Green	Forest Green	White	White	White	White	White	White	White	White	White	White	Black	Black	Black	
Red Rock	Red Rock*	Red Rock	Red Rock	Red Rock	Red Rock	Red Rock	White	White	White	White	White	White	White	White	White	White	Black	Black	Black	
White	White	Canvas	White	Canvas	Canvas	Canvas	Canvas	Canvas	Canvas	Canvas	Canvas	Canvas	Canvas	Canvas	Canvas	Canvas	White	White	White	
Canvas	Canvas	Canvas	Canvas	Canvas	Canvas	Canvas	Canvas	Canvas	Canvas	Canvas	Canvas	Canvas	Canvas	Canvas	Canvas	Canvas	White	White	White	
Sandstone	Sandstone	Terratone	Sandstone	Sandstone	Sandstone	Sandstone	Canvas	Canvas	Canvas	Canvas	Canvas	Canvas	Canvas	Canvas	Canvas	Canvas	White	White	White	
Dark Bronze	Dark Bronze	Dark Bronze	Dark Bronze	Dark Bronze	Dark Bronze	Dark Bronze	Canvas	Canvas	Canvas	Canvas	Canvas	Canvas	Canvas	Canvas	Canvas	Canvas	White	White	White	
Black	Black	Black	Black	Black	Black	Black	Canvas	Canvas	Canvas	Canvas	Canvas	Canvas	Canvas	Canvas	Canvas	Canvas	White	White	White	
Cocoa Bean	Cocoa Bean	Forest Green	Cocoa Bean	Cocoa Bean	Cocoa Bean	Cocoa Bean	Canvas	Canvas	Canvas	Canvas	Canvas	Canvas	Canvas	Canvas	Canvas	Canvas	White	White	White	
Forest Green	Forest Green*	Forest Green	Forest Green	Forest Green	Forest Green	Forest Green	Canvas	Canvas	Canvas	Canvas	Canvas	Canvas	Canvas	Canvas	Canvas	Canvas	White	White	White	
Red Rock	Red Rock*	Red Rock	Red Rock	Red Rock	Red Rock	Red Rock	Canvas	Canvas	Canvas	Canvas	Canvas	Canvas	Canvas	Canvas	Canvas	Canvas	White	White	White	
Wood*	Wood*	Stone	White	Sandstone	White	Wood	Wood*	Terratone	White	White	Wood*	White	White	Wood*	White	White	Black	Black	Black	
Canvas	Canvas	Canvas	Canvas	Canvas	Canvas	Canvas	Terratone	Terratone	White	White	Canvas	Canvas	Canvas	Canvas	Canvas	Canvas	Black	Black	Black	
Sandstone	Sandstone	Sandstone	Sandstone	Sandstone	Sandstone	Sandstone	Terratone	Terratone	White	White	Canvas	Canvas	Canvas	Canvas	Canvas	Canvas	Black	Black	Black	
Terratone	Terratone	Terratone	Terratone	Terratone	Terratone	Terratone	Terratone	Terratone	White	White	Canvas	Canvas	Canvas	Canvas	Canvas	Canvas	Black	Black	Black	
Dark Bronze	Dark Bronze	Dark Bronze	Dark Bronze	Dark Bronze	Dark Bronze	Dark Bronze	Terratone	Terratone	White	White	Canvas	Canvas	Canvas	Canvas	Canvas	Canvas	Black	Black	Black	
Black	Black	Black	Black	Black	Black	Black	Terratone	Terratone	White	White	Canvas	Canvas	Canvas	Canvas	Canvas	Canvas	Black	Black	Black	
Cocoa Bean	Cocoa Bean	Forest Green	Cocoa Bean	Cocoa Bean	Cocoa Bean	Cocoa Bean	Terratone	Terratone	White	White	Canvas	Canvas	Canvas	Canvas	Canvas	Canvas	Black	Black	Black	
Forest Green	Forest Green*	Forest Green	Forest Green	Forest Green	Forest Green	Forest Green	Terratone	Terratone	White	White	Canvas	Canvas	Canvas	Canvas	Canvas	Canvas	Black	Black	Black	
Red Rock	Red Rock*	Red Rock	Red Rock	Red Rock	Red Rock	Red Rock	Terratone	Terratone	White	White	Canvas	Canvas	Canvas	Canvas	Canvas	Canvas	Black	Black	Black	

* Interiors are wrapped. Wrap to match interior color OR Species. The wrapped substrate color is TERRATONE. See image below for wrap coverage area.

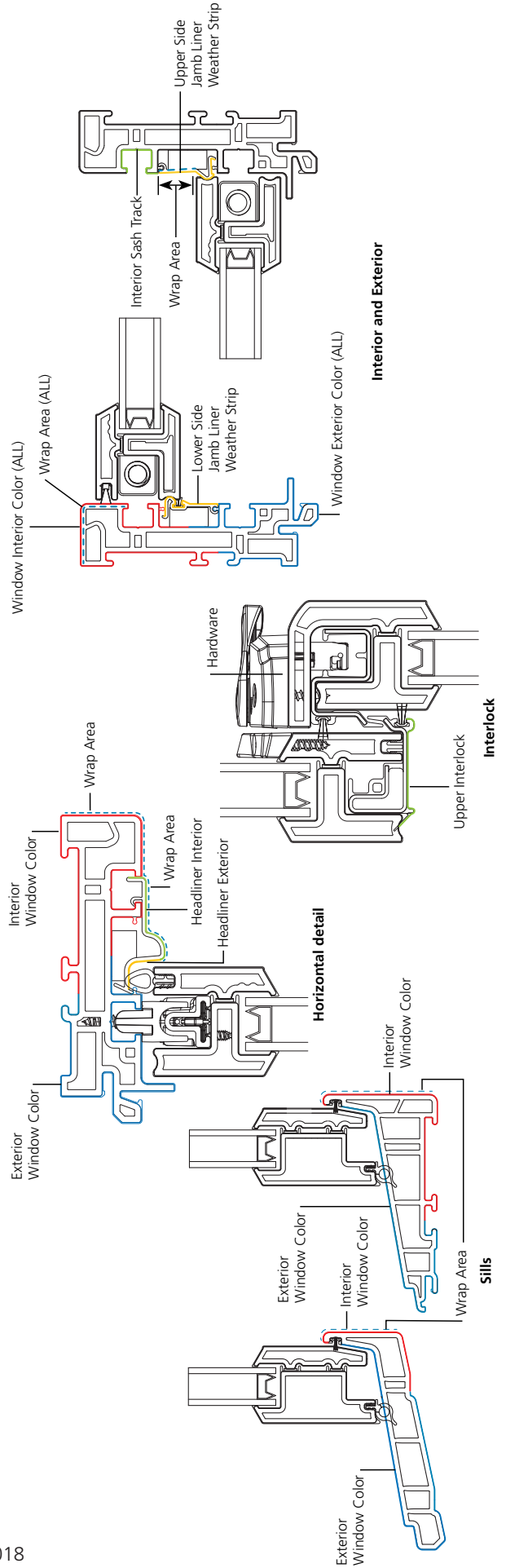

MIN / MAX SIZES

DG DOUBLE-HUNG WINDOW

FLAT SILL CONFIGURATIONS

MIN / MAX SIZES



Certain window sizes may have limited sash travel. Refer to the charts on pages 12-19 and 12-20, or call a customer service associate, or see the RbA Extranet for detailed information on limited sash travel and egress conformity in specific window applications.



Custom check rail heights may be specified to achieve different visible sash ratios, via NSPR.

Do not confuse sash ratio and colonial grille pattern designations. Sash ratio refers to the size relationship between upper and lower sash. Grille pattern refers to the number of lites in a colonial pattern grille.

* **Two locks required on units greater than or equal to 40"**

** **Two locks not available on units narrower than 23"**

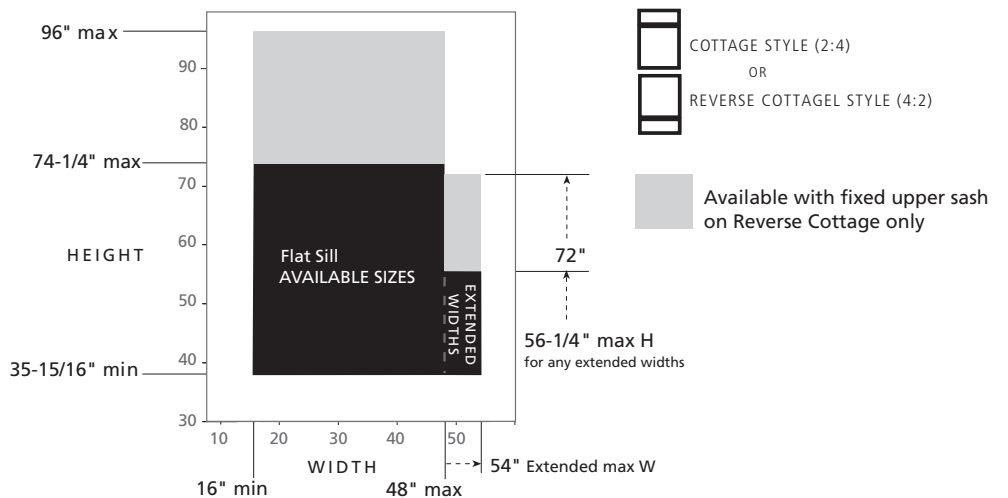
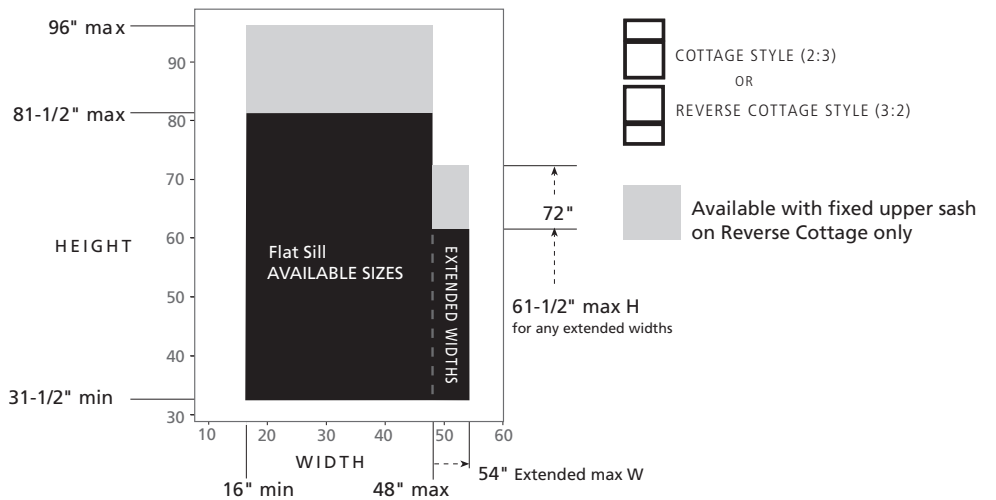
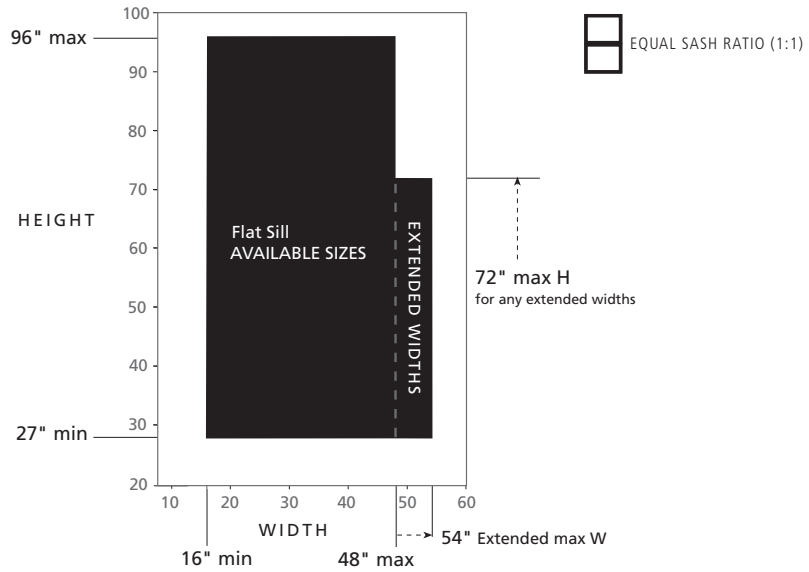

MIN / MAX SIZES

DG DOUBLE-HUNG WINDOW

FLAT SILL CONFIGURATIONS

MIN / MAX SIZES



Certain window sizes may have limited sash travel. Refer to the charts on pages 12-19 and 12-20, or call a customer service associate, or see the RbA Extranet for detailed information on limited sash travel and egress conformity in specific window applications.



Custom check rail heights may be specified to achieve different visible sash ratios, via NSPR.

Do not confuse sash ratio and colonial grille pattern designations. Sash ratio refers to the size relationship between upper and lower sash. Grille pattern refers to the number of lites in a colonial pattern grille.

* **Two locks required on units greater than or equal to 40"**

** **Two locks not available on units narrower than 23"**

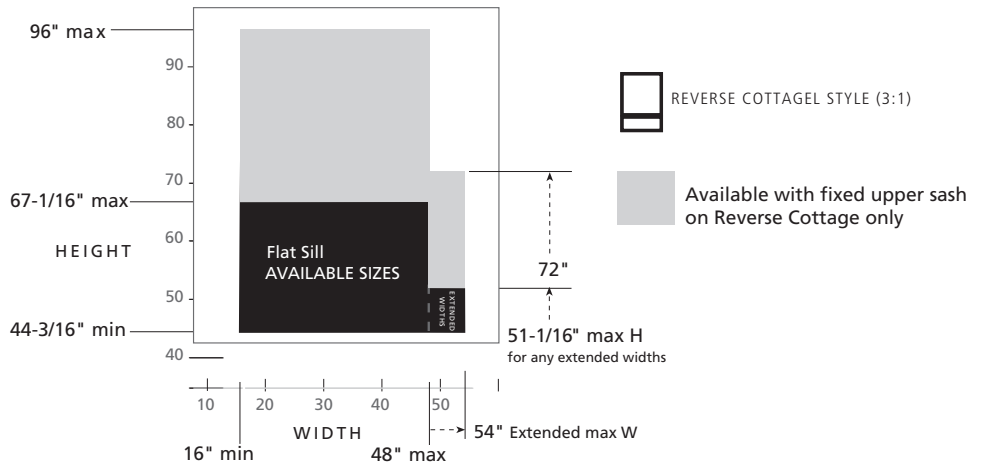
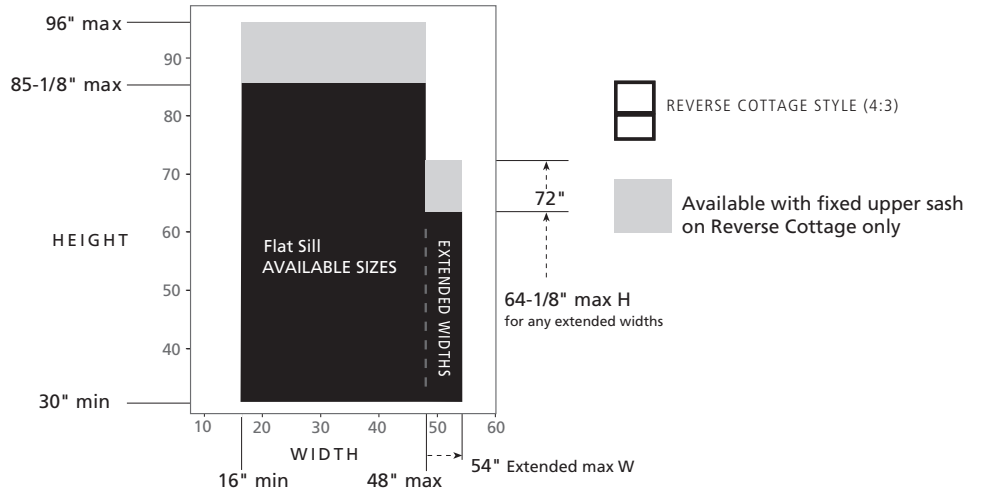

MIN / MAX SIZES

DG DOUBLE-HUNG WINDOW | SLOPED SILL CONFIGURATIONS

MIN / MAX SIZES



Certain window sizes may have limited sash travel. Refer to the charts on pages 12-19 and 12-20, or call a customer service associate, or see the RbA Extranet for detailed information on limited sash travel and egress conformity in specific window applications.



Custom check rail heights may be specified to achieve different visible sash ratios, via NSPR.

Do not confuse sash ratio and colonial grille pattern designations. Sash ratio refers to the size relationship between upper and lower sash. Grille pattern refers to the number of lites in a colonial pattern grille.

*** Two locks required on units greater than or equal to 40"**

**** Two locks not available on units narrower than 23"**

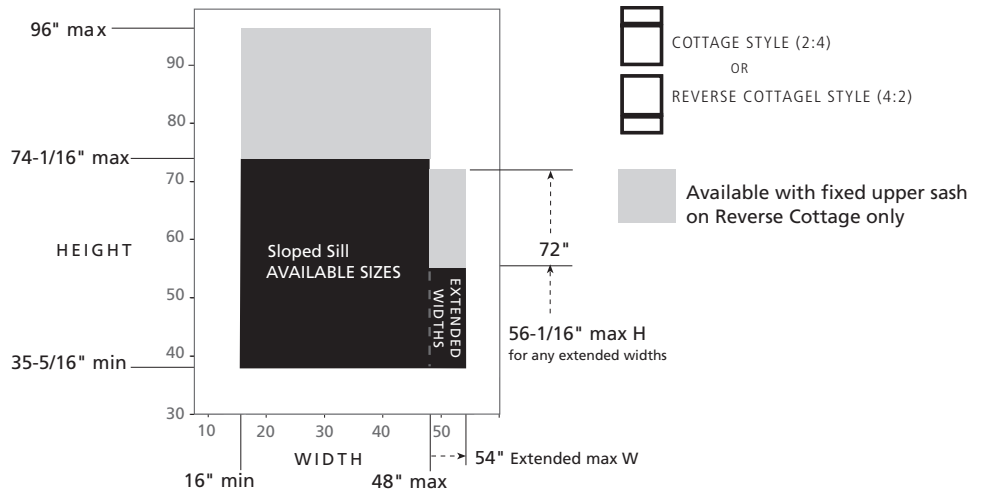
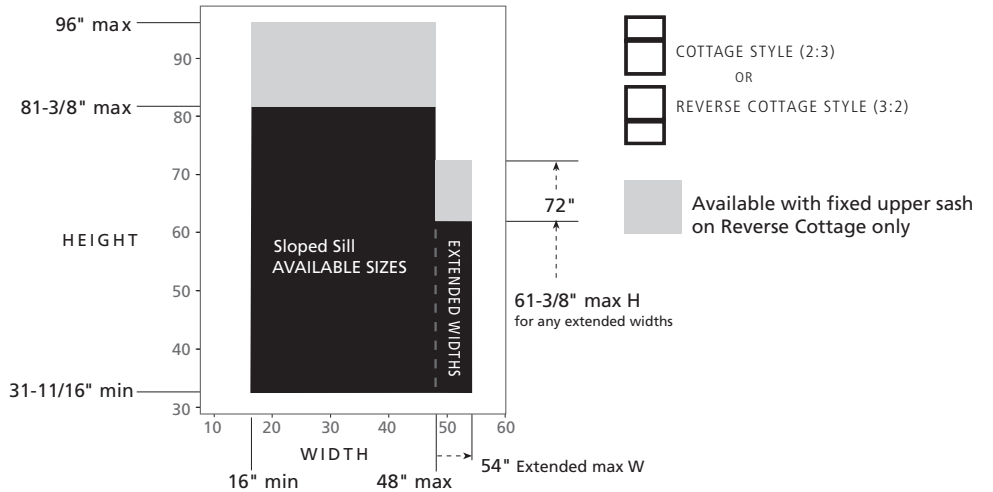
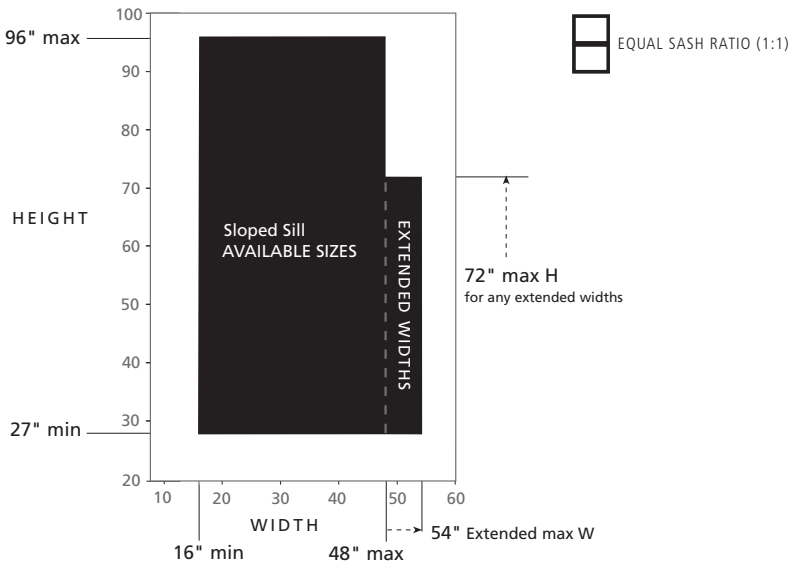

MIN / MAX SIZES

DG DOUBLE-HUNG WINDOW

SLOPED SILL CONFIGURATIONS

MIN / MAX SIZES



Certain window sizes may have limited sash travel. Refer to the charts on pages 12-19 and 12-20, or call a customer service associate, or see the RbA Extranet for detailed information on limited sash travel and egress conformity in specific window applications.



Custom check rail heights may be specified to achieve different visible sash ratios, via NSPR.

Do not confuse sash ratio and colonial grille pattern designations. Sash ratio refers to the size relationship between upper and lower sash. Grille pattern refers to the number of lites in a colonial pattern grille.

* **Two locks required on units greater than or equal to 40"**

** **Two locks not available on units narrower than 23"**

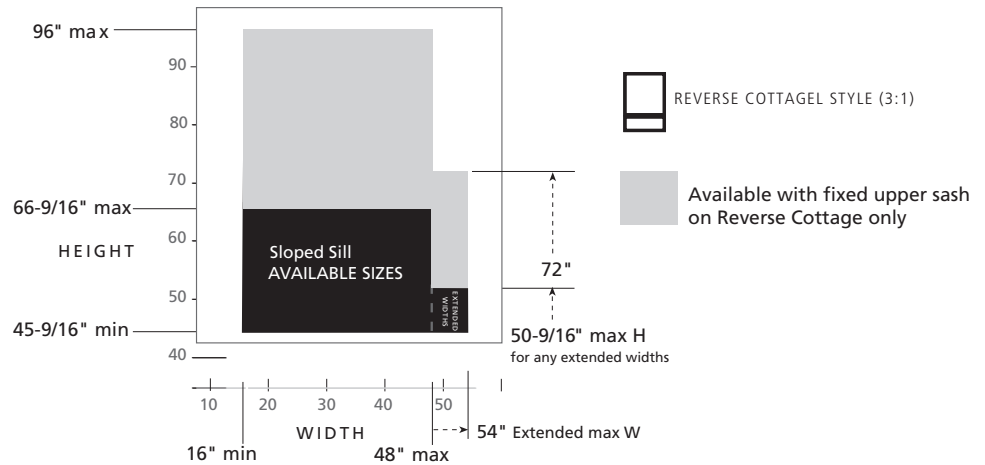
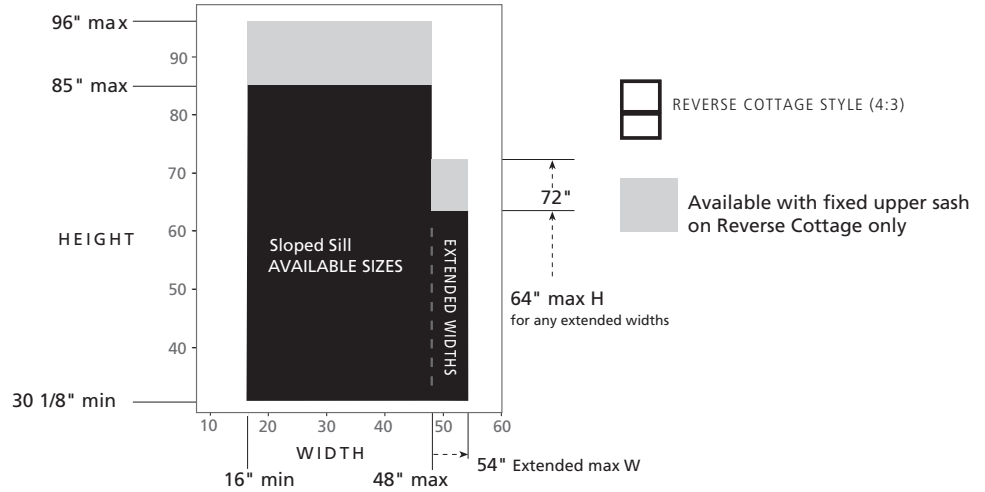

INSERT APPLICATION DG CONFIGURATIONS

POSSIBLE LIMITED SASH TRAVEL

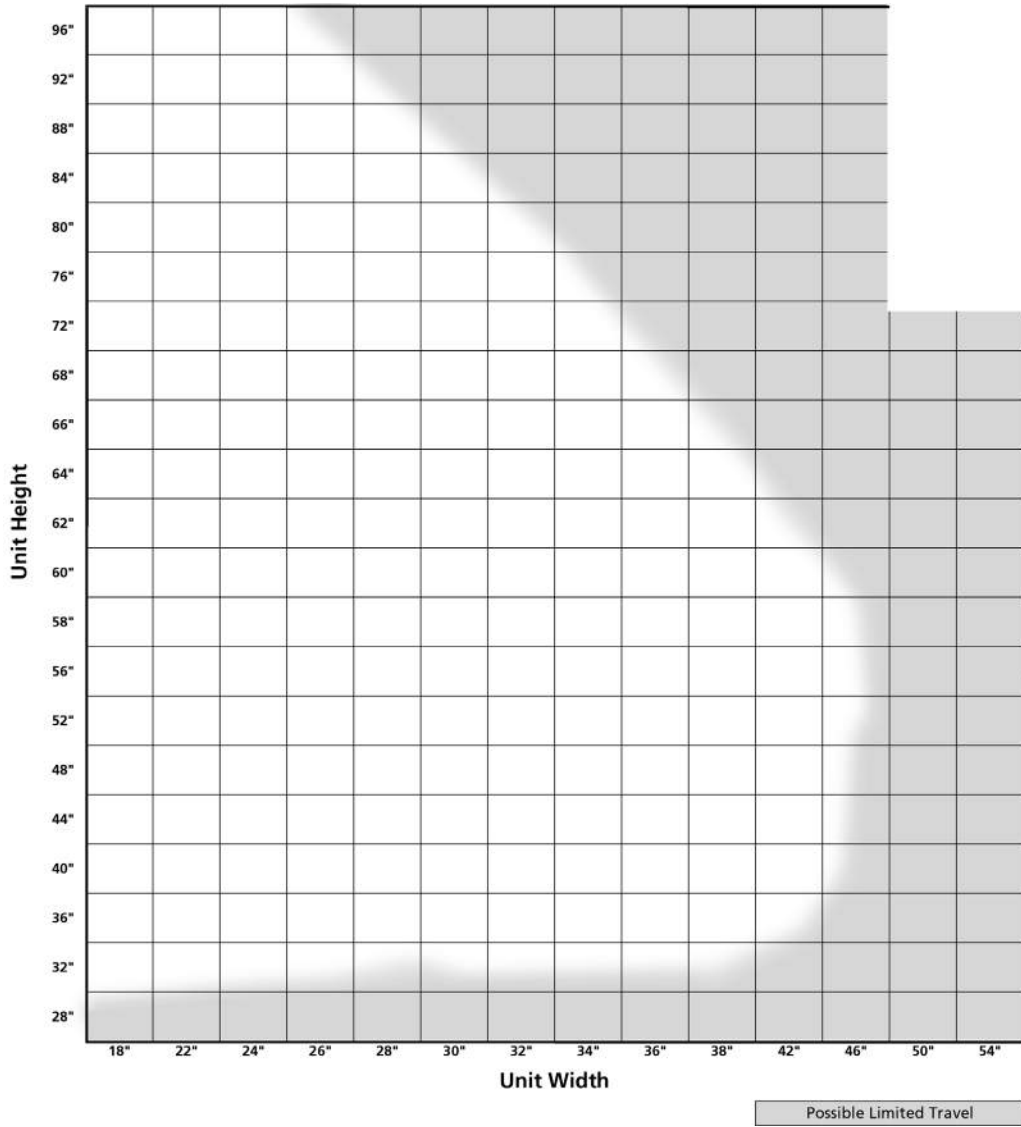

Due to the complexity of the DG design and advanced performance characteristics, limited travel sizes may vary. Please refer to the rSuite PriceCalc.SLIM configurator for details.

INSERT APPLICATION DG CONFIGURATIONS

POTENTIAL EGRESS SIZES

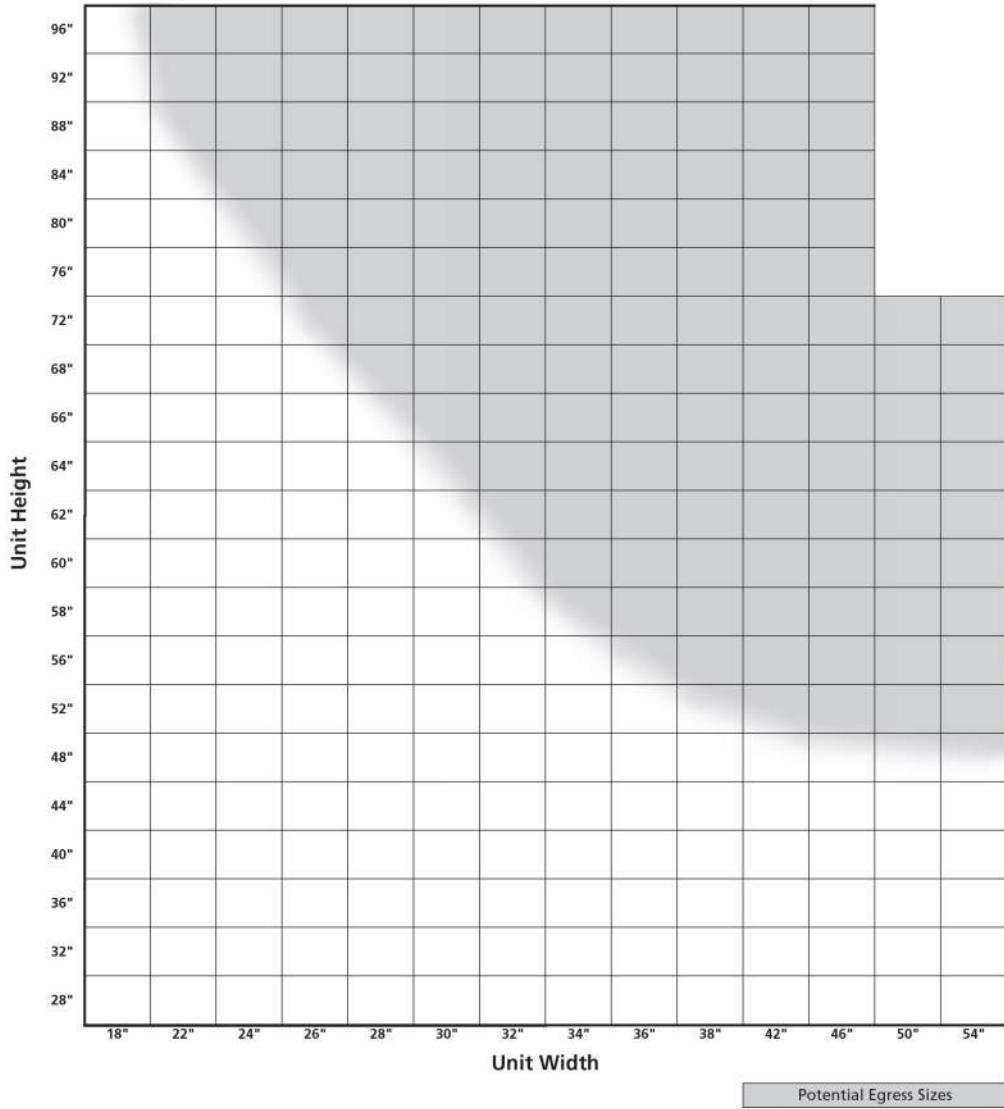

Due to the complexity of the DG design and advanced performance characteristics, egress sizes may vary by unit configuration. Please refer to the egress calculator in the rSuite application for details.

CHECK RAIL AND SASH HEIGHTS

To determine the clear opening dimensions or clear glass size of either sash, follow the steps below.

Upper Sash Height = (Unit Height - Sill Constant) X Multiplier + 3.546			
Sash Ratio	Sloped Sill Constant	Flat Sill Constant	Multiplier
1/3	8.47	9.19	0.25
1/2	8.47	9.19	0.33
2/3	8.47	9.19	0.40
1	8.47	9.19	0.50
4/3	8.47	9.19	0.57
3/2	8.47	9.19	0.60
2/1	8.47	9.19	0.67
3/1	8.47	9.19	0.75
Sash Width = Unit Width - 2.488			

Lower Sash Height = (Unit Height - Sill Constant) X Multiplier + 4.652			
Sash Ratio	Sloped Sill Constant	Flat Sill Constant	Multiplier
1/3	8.47	9.19	0.75
1/2	8.47	9.19	0.67
2/3	8.47	9.19	0.60
1	8.47	9.19	0.50
4/3	8.47	9.19	0.43
3/2	8.47	9.19	0.40
2/1	8.47	9.19	0.33
3/1	8.47	9.19	0.25
Sash Width = Unit Width - 2.488			



Check Rail Height = (Unit Height - Sill Constant) X Multiplier + 3.218			
Sash Ratio	Sloped Sill Constant	Flat Sill Constant	Multiplier
1/3	8.47	9.19	0.25
1/2	8.47	9.19	0.33
2/3	8.47	9.19	0.40
1	8.47	9.19	0.50
4/3	8.47	9.19	0.57
3/2	8.47	9.19	0.60
2/1	8.47	9.19	0.67
3/1	8.47	9.19	0.75

- Step 1:** Select appropriate chart from left (Check Rail Height, Upper Sash Height or Lower Sash Height).
- Step 2:** Find desired sash ratio in left-most column and make note of appropriate Sill Constant (Sloped or Flat) and Multiplier from the chart.
- Step 3:** Input your known Unit Height and the noted values from Step 2 into the formula from the Header from the desired chart. Calculate formula for desired value.



Custom check rail heights are available upon request.

For most areas, **egress opening codes** dictate minimum clear opening width, height, and square feet. Check with your local code officials to determine the precise egress codes for each home.

Clear Opening Widths are often called **"Egress Opening"** Dimensions.

For detailed information on limited sash travel and egress conformity in specific window applications, refer to the charts on the previous pages 12-19 and 12-20, or call a customer service associate, or see the RbA Extranet.

Example: A homeowner would like to know what the check rail height would be for a 3 over 2 Sloped Sill DG Double Hung that is 58 'A" tall.

- Step 1:** Choose the Check Rail Height chart.
- Step 2:** From the Sash Ratio Column, choose the 3/2 row and note the Sloped Sill Constant of 8.47, and the Multiplier of 0.60.
- Step 3:** Calculate
 - $Check\ Rail\ Height = (58.25 - 8.47) * 0.60 + 3.218$
 - $Check\ Rail\ Height = (49.78) * 0.60 + 3.218$
 - $Check\ Rail\ Height = 29.868 + 3.218$
 - $Check\ Rail\ Height = 33.086$

INSERT APPLICATION DG CONFIGURATIONS

When the old window frame is solid and/or interior or exterior trim needs to be saved, an insert application is appropriate. These installations are also typically less disruptive to the home. A typical installation requires removing the old sash and any interfering hardware or trim from the existing window frame, yet leaves the frame and trim intact. The DG Double-Hung provides numerous Frame/Sill configurations and a few exterior trim options to satisfy the specific needs of the application.

SLOPED SILL & FLAT SILL DG DOUBLE-HUNG WINDOWS WITH INSERT FRAME OR BASE FRAME

If the existing window frame has a sloped sill of 6 degrees or greater, it is recommended to use a Sloped-Sill configuration. This will maximize the replacement window's clear glass height as the sill on the new window is "sloped" at a 12 degree angle. However, the sill is void of an exterior kerf on the outer nose and thus the window does not allow for attachment of accessories at the sill, such as L-Trim or aluminum coil. A DG Double-Hung with a Sloped Sill cannot be configured with ANY exterior trim components such as brickmould or overfit.

If the existing window frame has a sill with a slope of less than 6 degrees, it is recommended to use a Flat-Sill configuration. The Flat-Sill will seat better in such applications with minimal shimming required. Additionally, the Flat-Sill contains an exterior kerf to provide increased flexibility with trims or coil AND can be configured with brick mould or overfit systems. The Flat-Sill is also the appropriate selection when specifying a DG Double-Hung used in a bay/bow frame, OR when mulled next to a Universal Picture window (PWU).

Both the Sloped-Sill AND Flat-Sill may be specified to be used in conjunction with an Insert Frame OR a Base Frame configuration. The Insert Frame consists of a factory applied notch in the outer nose creating a 3-3/16" frame which is ideal for nesting inside of an existing old double-hung jamb pocket (insert application).

The Base Frame is consistent with the Universal Frame strategy which exists on all other Renewal by Andersen products. It consists of a 4" frame depth and flat interior surface for sealing or trimming to. Both the Insert Frame AND Base Frame are provided with an exterior kerf for accessory attachment, such as L-Trim or aluminum coil.

INSERT APPLICATION DG CONFIGURATIONS

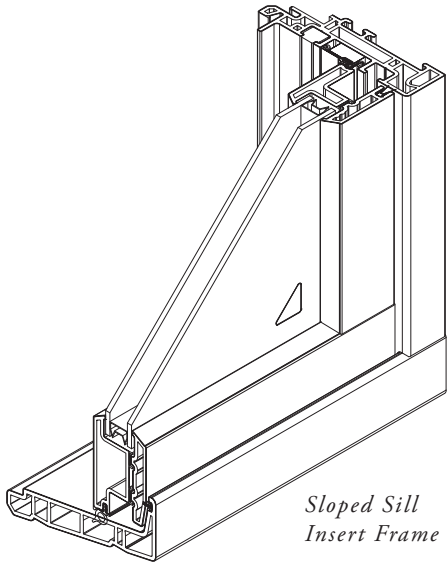

*Sloped Sill
Insert Frame*

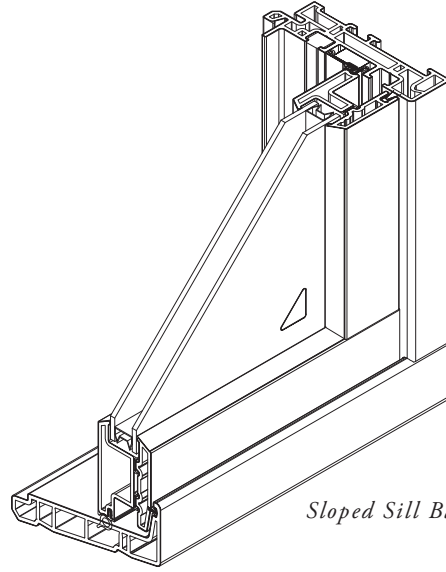

Sloped Sill Base Frame

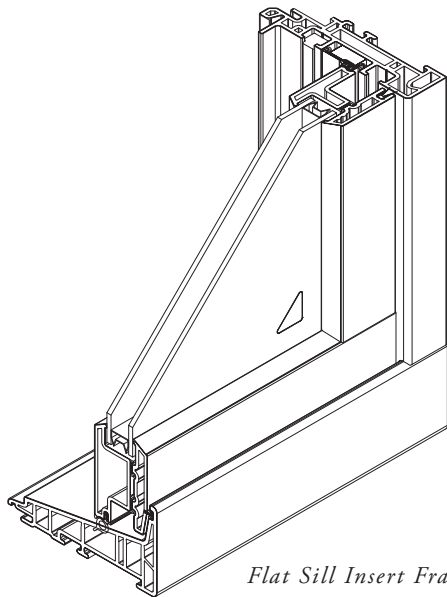

Flat Sill Insert Frame

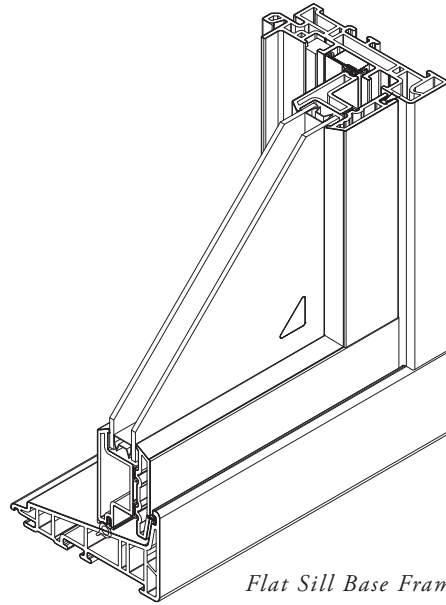

Flat Sill Base Frame

INSERT APPLICATION DG CONFIGURATIONS

VERTICAL SECTIONS

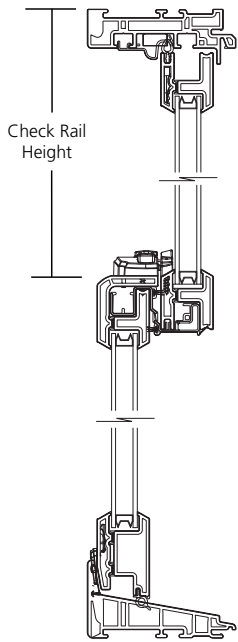

Flat Sill Base Frame

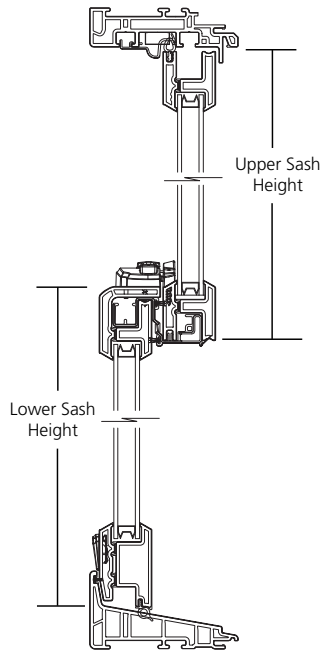

Flat Sill Insert Frame

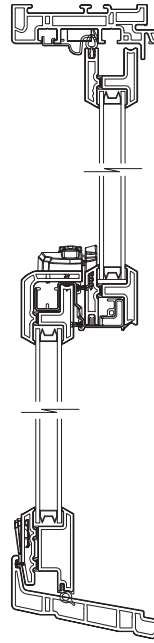

Sloped Sill Base Frame

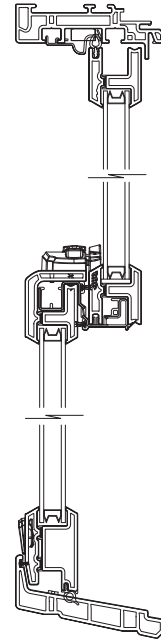

Sloped Sill Insert Frame

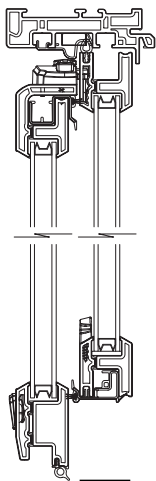

Flat Sill Base Frame

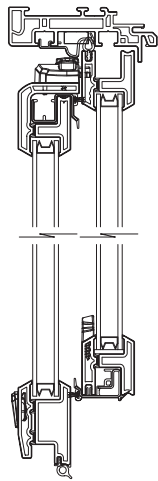

Flat Sill Insert Frame

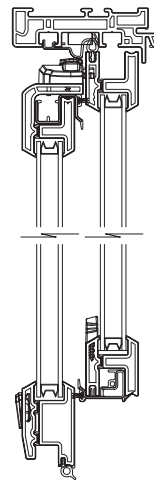

Sloped Sill Base Frame

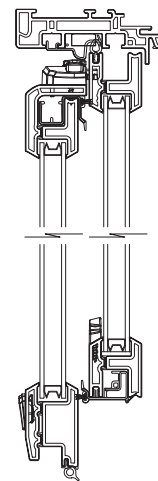

Sloped Sill Insert Frame

Clear Opening Height

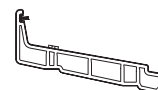
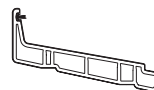
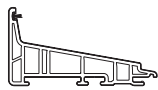
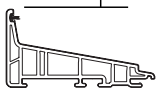

Window profiles shown for measurement purposes.

FULL-FRAME APPLICATION DG CONFIGURATIONS

When the old window is deteriorated beyond repair or opening modifications are required, a full frame application is appropriate. These installations can be more disruptive to a home and typically require complete removal of the existing window as well as the interior and exterior trim components. The DG Double-Hung provides a Flat Sill/Extension Jamb (EJ) frame with multiple exterior trim configurations to satisfy the specific needs of the application.

FLAT SILL DG DOUBLE-HUNG WINDOWS WITH EJ FRAME

The Flat Sill DG Double-Hung with Extension Jamb frame is the ideal choice for a Full Frame application. It consists of the DG Double-Hung Flat Sill paired with a 4" universal frame profile. The interior of the window contains an EJ kerf to accept an extension jamb. The exterior perimeter of the window is provided with a kerf to accept trim components such as L-Trim, F-Trim or coil. Additionally, the Flat Sill DG Double-Hung Windows with EJ Frame can be fitted with a nailing flange OR multiple configurations of brick mould or overfit. The Flat Sill DG Double-Hung Window with EJ Frame is a highly flexible solution to satisfy the specific needs of the application.

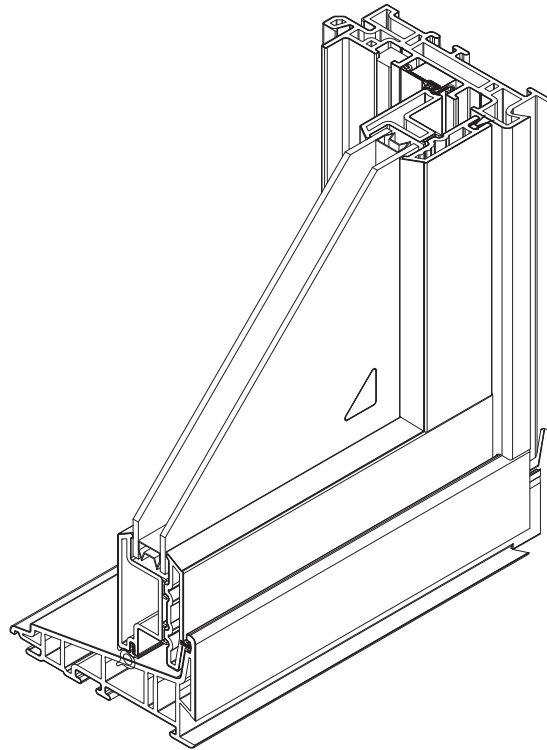

FULL-FRAME APPLICATION DG CONFIGURATIONS

VERTICAL SECTION

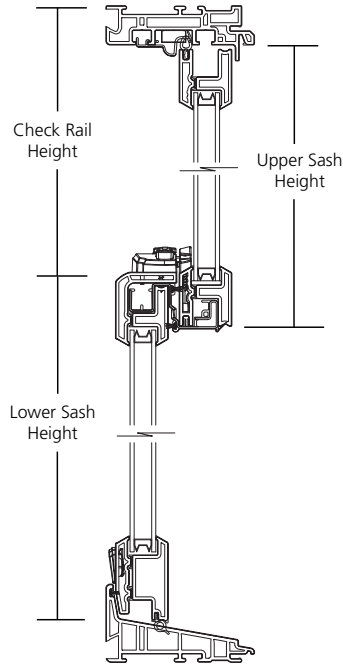

*Flat Sill Extension
Jamb Frame*

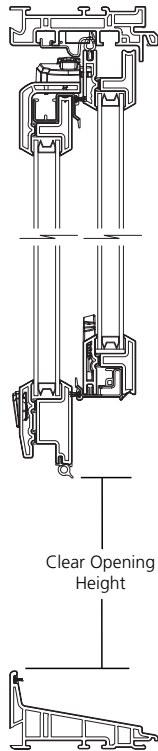

*Flat Sill Extension
Jamb Frame*

DG DOUBLE-HUNG WINDOW AND RELATED PATENTS

DG DOUBLE-HUNG WINDOW

- Double-Hung Window - U.S. Patent Number: Des. 394,115

The ornamental design for a DG Double-Hung window

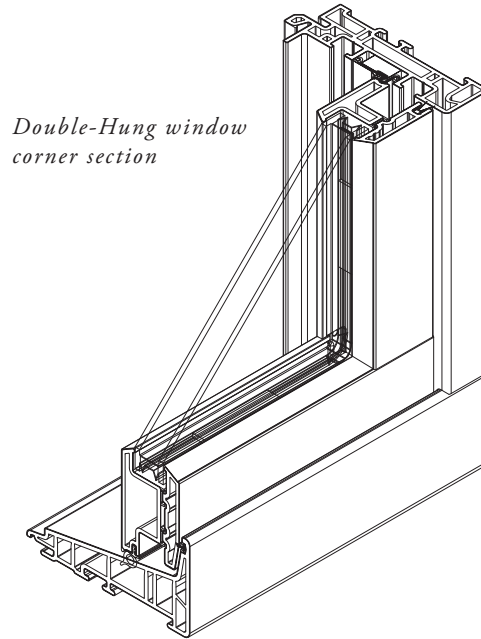

Double-Hung window corner section

- Extension Jamb – U.S. Patent Number: Des. 5,555,684

An extension jamb extends the depth of a frame to accept a replacement window. Our patented design improves the standard method of securing the jambs to the window frame with glue or nails, which is the method used by many manufacturers.

The design creates a snap-in fit of the extension jamb into the window frame. This is aesthetically more pleasing and eliminates problems with staining and finishing that may occur with glue or nail holes.

Installing an extension jamb

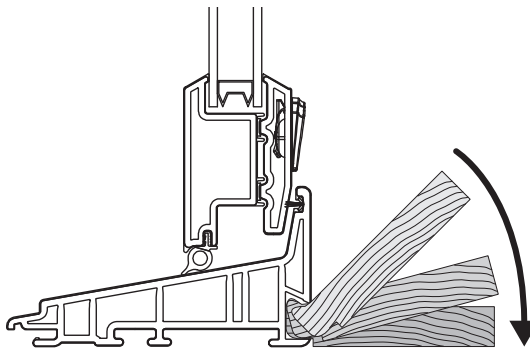

DG Double-Hung sill profile

DG DOUBLE-HUNG WINDOW AND RELATED PATENTS, cont.

DG DOUBLE-HUNG WINDOW

- Joint Structure (Mortise/Tenon) – U.S. Patent Number: Des. 5,603,585

Renewal by Andersen® has a patented design and manufacturing method to make a welded corner with the appearance of a traditional, hand-crafted mortise-and-tenon joint. By end-cutting the sash members in a unique way, we provide a welded corner on the exterior surface of the sash that provides strength and excellent weathertight construction, while the interior portion of the sash parts are joined to create a mortise-and-tenon-style corner joint. This marriage of function and traditional window style is unique in the window replacement industry.

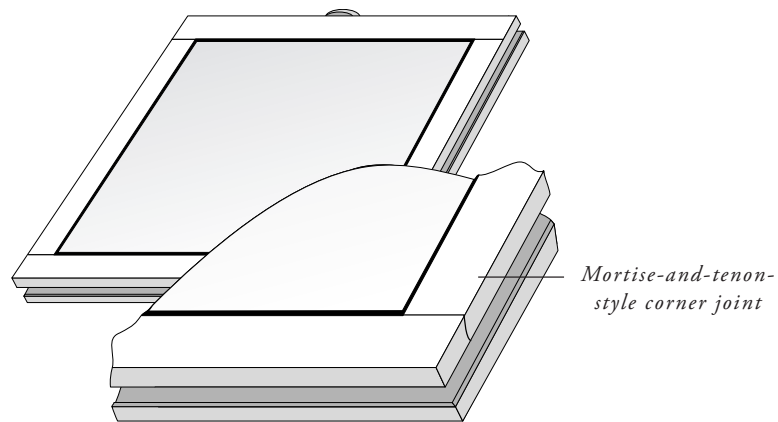

- Upper sash single point actuation tilt system
- Lower interlock integrated finger release tilt latch system

CONTENTS — CASEMENT WINDOW AND FIXED-SASH WINDOW

Casement Window—General

- Advantages and Applications 1-2
- Casement Exploded View 1-3
- Standard Features 1-4
- Options..... 1-6
- Grille Options 1-9

Window Component Color Combination Chart 1-10

Window Color/Wood Combinations 1-11

Window Installation Accessories 1-12

Casement Unit Offerings..... 1-13

Casement Single Window

- Min/Max Sizes 1-14
- Clear Opening, Clear Glass, and Vent Opening Dimensions..... 1-15
- Wide-Open-Hinge 1-16
- Window Opening and Dimensional Specifications 1-17

Casement Double Window

- Min/Max Sizes 1-18
- Relative Performance 1-19
- Clear Opening, Clear Glass, and Vent Opening Dimensions..... 1-20
- Window Opening and Dimensional Specifications 1-21

Casement Triple Window

- Min/Max Sizes 1-22
- Relative Performance 1-23
- Clear Opening, Clear Glass, and Vent Opening Dimensions 1-25
- Custom Mull Post Capability..... 1-26
- Window Opening and Dimensional Specifications 1-27

Fixed Window

- Advantages and Applications 1-28
- Min/Max Sizes 1-29

CASEMENT WINDOW

ADVANTAGES AND APPLICATIONS

The Renewal by Andersen® casement window consists of one or multiple sashes in a single frame. The sash can be hinged on the right or left side and pivots outward. Sash opening is controlled by a roto gear operator on the sill. A single sash lock lever activates multiple lock points to enhance security, and pulls the sash in tightly against the weatherstrip on the sash and frame. Insect screens are installed on the interior of the frame.



*Casement
Replacement Windows*

ADVANTAGES

- Allows the most ventilation of any window type.
- Open sash can “catch” breezes from multiple directions.
- Multiple weatherstrips provide a weather tight seal when sash is closed and locked.
- Patented Fibrex® material is more rigid than vinyl, allowing more glass area.
- Fibrex material with low-maintenance capstock gives a rich, low-luster finish to sash and frame, similar to painted wood.
- Smooth radius surfaces on frame and sash are pleasing to the eye and easier to clean.
- Mortise and tenon appearance on the interior and exterior sash and frame corners give a traditional hand-crafted look.

APPLICATIONS

- Widely used to replace other styles of windows.
- Offers dramatic design accents when combined with fixed windows.
- Recommended for use over countertops and other wide obstructions because operation is controlled by turning a handle—an easier motion than lifting or sliding sash.
- Should not be used in areas where the projecting sash could obstruct outside walkways.
- Visually compatible with other Renewal by Andersen products.
- Corrosion-resistant casement hardware is available for use in harsh and corrosive environments such as heavy industrial or coastal areas.

EXPLODED VIEW

CASEMENT WINDOW

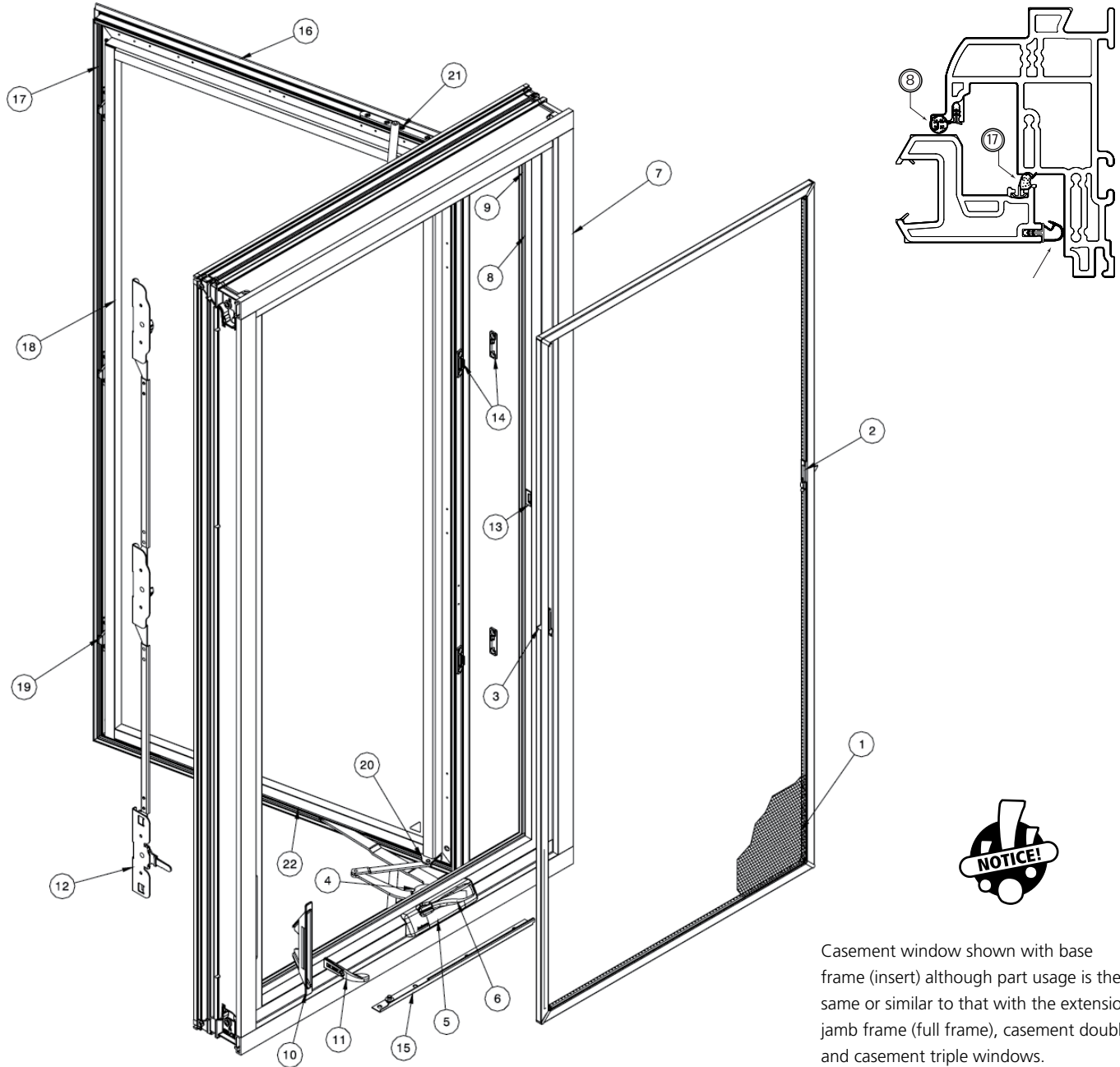

Casement window shown with base frame (insert) although part usage is the same or similar to that with the extension jamb frame (full frame), casement double, and casement triple windows.

CASEMENT WINDOW COMPONENTS

- | | | |
|---|-------------------------------------|---|
| 1. Insect screen | 8. Frame weatherstrip | 16. Sash rain screen weatherstrip |
| 2. Universal insect screen latch retainer | 9. Hole plug | 17. Sash bulb weatherstrip |
| 3. Insect screen latch | 10. Bezel | 18. Casement sash |
| 4. Casement dual arm operator | 11. Lock handle | 19. Lock strike |
| 5. Operator cover | 12. Lock assembly | 20. Casement sash bracket
(Corrosion-resistant upgrade option) |
| 6. Operator handle | 13. Insect screen grommet | 21. Hinge |
| 7. Frame | 14. Sash and frame snugger | 22. Operator track |
| | 15. Corrosion-resistant hinge track | |

STANDARD FEATURES

CASEMENT WINDOW

Described below are features that contribute to the casement window's low maintenance, energy efficiency, ease of operation, and pleasing appearance.

- **Frame** – Made of rigid Fibrex® material, a unique structural composite of wood fibers and a special thermoplastic polymer. Developed by Andersen®, Fibrex® material combines the strength and stability of wood with the low-maintenance features of vinyl.
- **Sash** – Corner keys provide durable, watertight corners. The mortise and tenon joinery complements the frame. A high-performance silicone sealant provides a watertight seal between glass and sash.
- **Glazing** – High-Performance™ Low-E4® glass with an inert, energy-efficient gas, is standard for every window. Glass is placed into sash before assembly for a strong, weather tight assembly. A high-performance silicone sealant provides a watertight seal between glass and sash. See options on page 1-6 for other glass choices.
- **Glass spacer** – The patented low-conductivity stainless steel spacer resists heat transfer four to five times better than aluminum spacers and is stronger than silicone or plastic spacers used by many other manufacturers.

STANDARD FEATURES CONT.

CASEMENT WINDOW

Glass exterior when exposed to sunlight

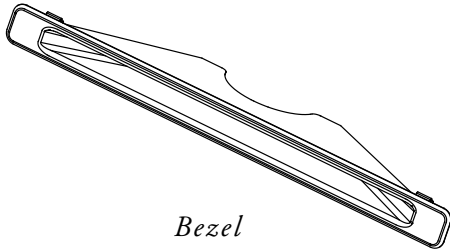

Bezel



Regular Glass

High-Performance™
Low-E4® Glass

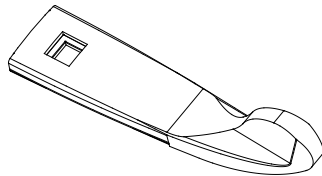

Sash Lock Handle

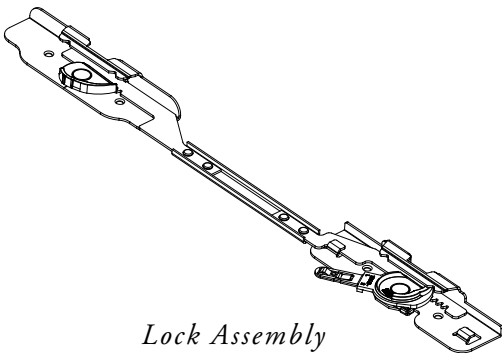

Lock Assembly

- **Low-maintenance exterior coating**—A highly durable microscopic coating of titanium dioxide (TiO₂) is applied to the exterior glass surface during the glass manufacturing process. High-Performance Low-E4 glass exterior is self-activating by exposure to sunlight. When activated by sunlight, it loosens dirt, dust and organic material which are then washed away by rain. The glass dries faster and reduces water spotting by up to 99%. (See illustration on this page.)

The unique exterior coating works similarly to a rechargeable battery. Once the coating is activated or “charged,” it will hold its activation for some time. The more sunlight it receives, the better the activation. When re-exposed to sunlight, the coating will recharge after periods of lower sunlight levels.

- **Removable protective film**— Packaging features a clear protective film that is factory applied to both the interior and exterior glass surfaces to help protect the glass from shipping and installation damage.
- **Weatherstrip** – A three-piece weatherstrip system of a foam-filled bulb applied to the frame, a foam-filled bulb applied to the sash and a flexible bulb weatherstrip applied to the sash provide a tight robust seal.
- **Casement Sash Lock Assembly and Lock Bar System** – One sash lock lever activates the lock assembly with up to three locking points per sash for greater security and better weather-tightness. The lock bezel is styled to fit and visually match the smooth radiused interior surface.

Window Height	Number of Locking Points
Less than 27"	1
27" to 53-15/16"	2
54" to 80"	3

STANDARD FEATURES, CONT.

CASEMENT WINDOW

Casement operators

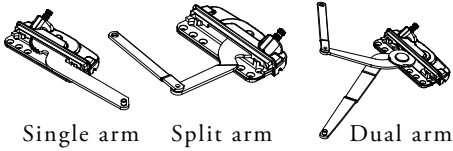

Casement hinges

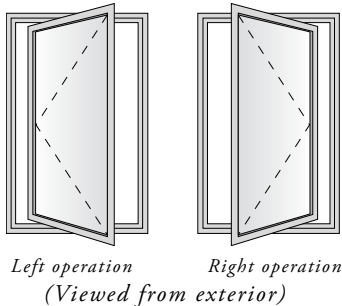
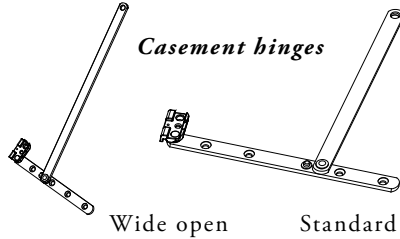

- **Casement Operator** – The operator uses a hardened steel worm and gear drive for smooth, easy control. The operator includes a high-pressure die-cast zinc operator housing, crank handle and knob. The operator is handed providing a symmetrical appearance for double and triple sash casement units. The casement operator is styled to fit and visually match the smooth curved interior surface. The standard folding handle offers an integrated look when nesting in the operator cover and allows for easy insect screen removal.
- **Casement/Awning Hinge** – The dual-pivot hinge provides a smooth operation, and a corrosion-resistant finish complements the frame color. For easy cleaning, sash moves toward center of the opening, allowing hand to reach both sides of the glass from the inside.
- **Determining RH/LH Operation** – Right-hand or left-hand operation (opening) is designated by the side on which the hinges are mounted *when viewed from the exterior*.
- **Insect Screen** – The standard insect screen is made with an aluminum frame and an easy-to-see-through fiberglass screen cloth (18x16 per inch mesh) in a glare-resistant charcoal gray finish. The frame is reinforced with a unique nylon corner spline to keep it from sagging and is secured to the window with wing blade fasteners in nylon housings. Aluminum and TruScene® insect screens are available for all sizes. Optional pine, oak and maple veneer are available for TruScene insect screens - see options on following page for details.
- **Interior/Exterior Color and Component Color** – Refer to the Casement Window Component Color Combination Chart on page 1-10 for standard (and optional) color combinations.

OPTIONS

CASEMENT WINDOW

The options shown here are available for all Renewal by Andersen® casement windows.

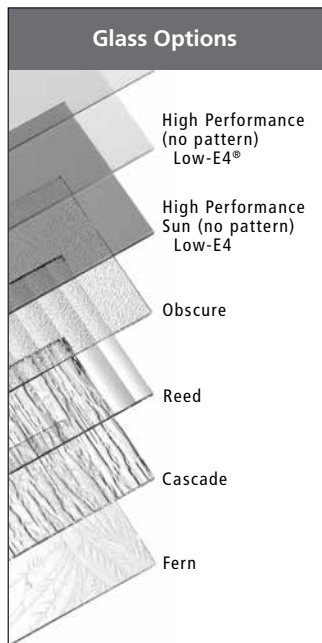

- **Dual-colors and Stainable Wood Interior Veneer** – Dual color windows are available that have different interior and exterior colors. Stainable wood interior veneers are also available (pine, maple and oak).
The Casement Window Component Color Combination Chart on page 1-10 shows these different combinations and the default color of individual components for these combinations. Alternative component (e.g., grille, insect screen, hardware) color combinations are available upon request.
- **Glass Patterns** – Standard windows have no glass pattern whatsoever. Optional patterns are as follows:
 - Obscure
 - Cascade
 - Reed
 - Fern (not available on 1:2:1 casement triple windows wider than 104-1/2”)
- **Glass Coating** – High-Performance™ Low-E4® coating is standard with all windows. Optional glazings are as follows:
 - Clear (no coating)
 - High-Performance Low-E4 Sun tinted coating
 - SmartSun™
- **Tempered Glass** – Tempering is an option for all available glass options. Untempered glass is standard.
- **Glass Breather Tubes** – Breather tubes are available for glass intended for high-altitude installations. It is important to note that breather tubes will decrease the thermal performance of the unit. Refer to the Technical Data (Section 8) in this Spec and Tech Manual for altitude specifics.

OPTIONS, CONT.

CASEMENT WINDOW

- **Corrosion-Resistant Hardware** – Made from 300 series stainless steel, this material is more resistant to corrosion due to harsh, acidic or corrosive environments such as heavy industrial or coastal areas.
- **TruScene® Insect Screen Frame**—Micro-fine stainless steel mesh (25 x 25 per inch mesh) that provides over 50% more clarity than standard Andersen® insect screens. TruScene Insect Screen is an option for all operable Renewal by Andersen® window styles.
- **Veneered TruScreen® Insect Screen Frame**—Available in pine, maple and oak.
- **Aluminum Insect Screen** – Identical to the standard insect screen but with a durable aluminum screen cloth (18 x 16 per inch mesh) in a glare-resistant charcoal gray finish.
- **Wide Open Hinge** – Special corner pivot hinges increase the window clear opening by approximately 4" (important for egress code requirements). **Note:** Washing the window from the interior is not possible with this hinge.
- **Estate™ Hardware** – Estate hardware is available for all operating windows and is available in high-performance bright brass, antique brass, high-performance satin nickel, distressed nickel, brushed chrome, polished chrome, distressed bronze and oil-rubbed bronze. The Estate hardware components for casement windows are pictured below.
- **Opening Control Device** – This optional field applied item voluntarily restricts opening to a maximum of 4 inches. Its release feature will still allow increased opening capability when needed and will automatically re-engage when the sash is closed. The Opening Control Device complies with ASTM F2090-08&-10.

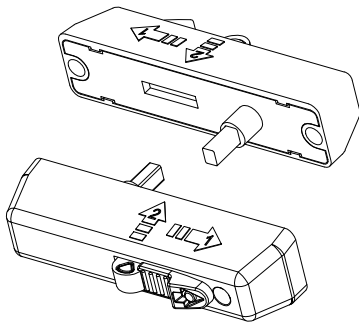

Opening Control Device

The devices are available as either right or left hand operating sash in White and Stone color only.

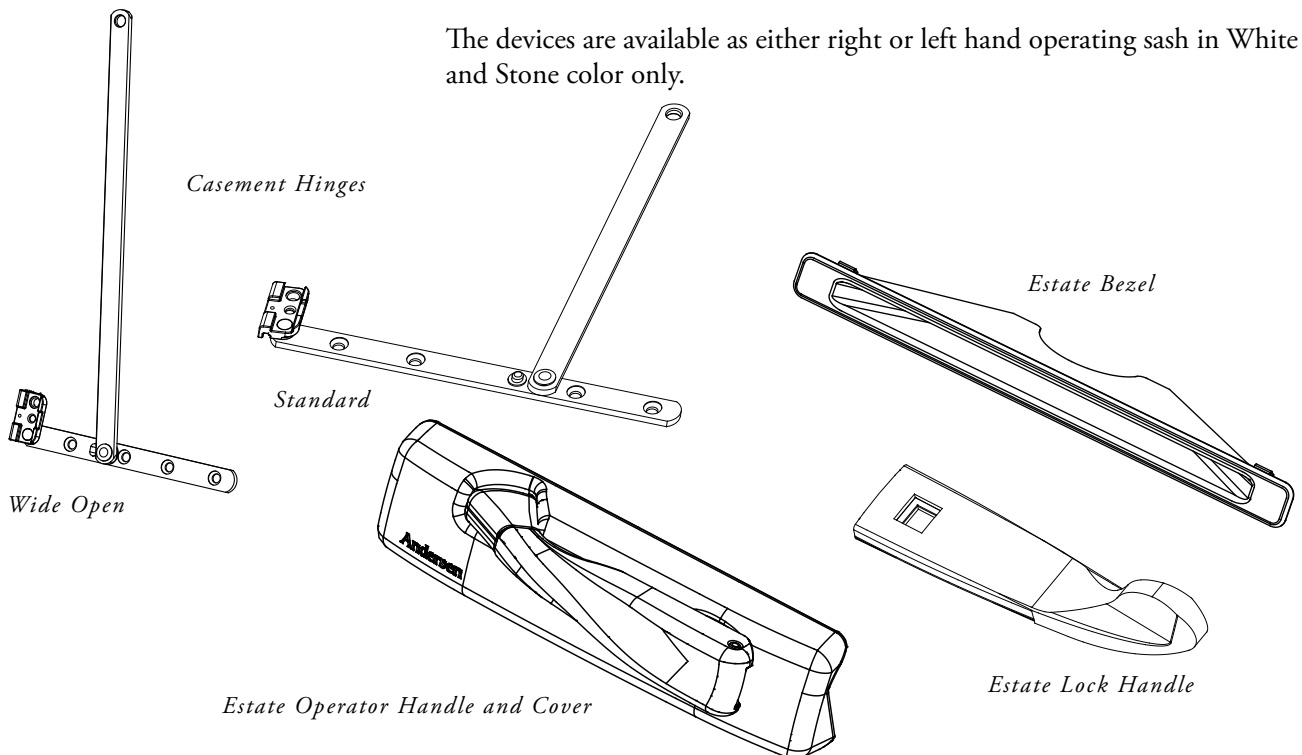

Casement Hinges

Standard

Wide Open

Estate Bezel

Estate Operator Handle and Cover

Estate Lock Handle

OPTIONS, cont.

CASEMENT WINDOW

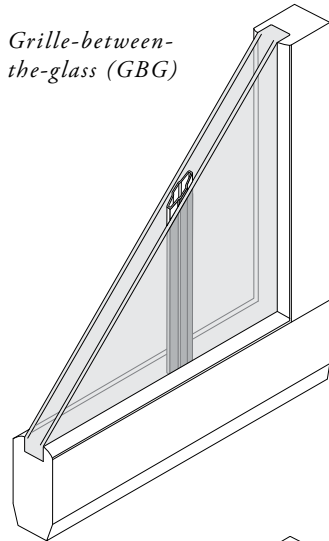

Grille-between-the-glass (GBG)

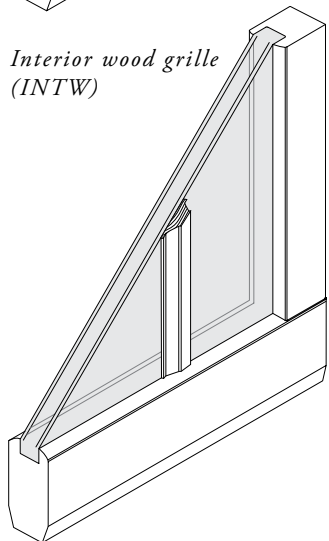

Interior wood grille (INTW)

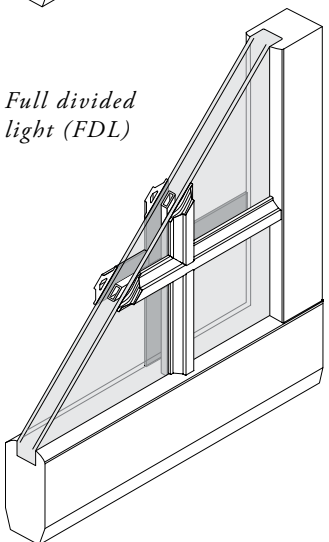

Full divided light (FDL)

Available Grille Types

Three grille types are available. The interior and exterior sides of the grilles are color-coordinated with each side of the window frame. Consult the color combination charts in each window product section for detailed color information.

Grille-Between-the-Glass (GBG)

Sculpted aluminum grille members are manufactured between the glass panes, and are available in two widths. Enamel finish replicates interior and exterior face of window. If wood interior, interior facing surface will be gray.

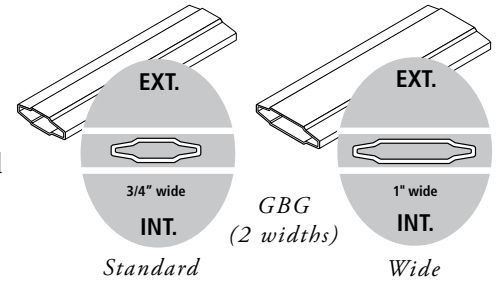

Interior Wood Grille (INTW)

With the option of hardwood maple or oak, these grilles snap into clips placed around the interior side of the sash and may be removed to clean the glass. These high-definition interior wood grilles are available in two different widths.

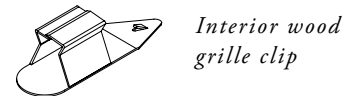
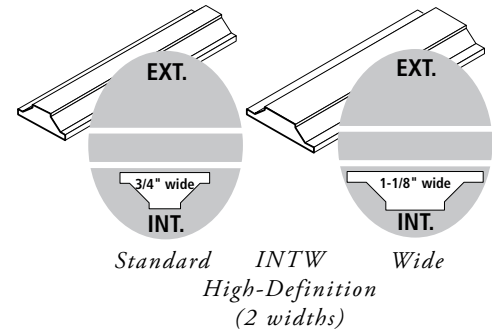

Full Divided Light (FDL) Grille

FDL grilles provide the classic look of a true divided light window. The high-definition exterior grille is made from Fibrex® material and is available in two different widths. Between the glass panes, an aluminum spacer stands slightly away from each pane to maintain thermal performance. The high-definition interior wood grille is available in hardwood, maple or oak and in two different widths, and may be permanently applied or removable.

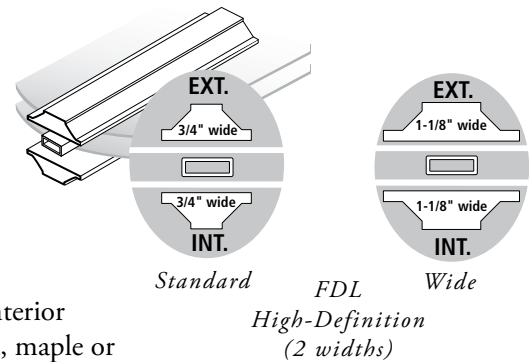

GRILLE OPTIONS

CASEMENT WINDOW

- **Available Grille Patterns** – Grille pattern options include colonial, farmhouse, prairie, and modified prairie (viewed from exterior).

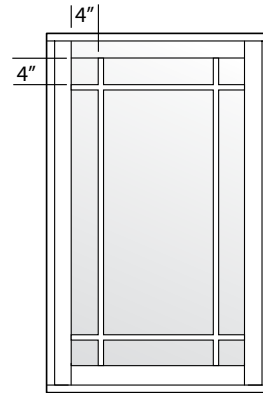
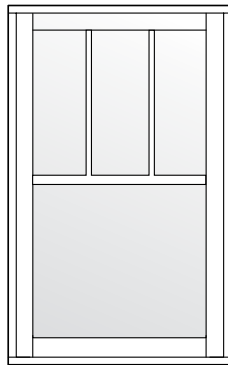
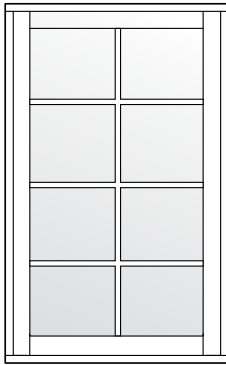

COLONIAL

Refer to colonial pattern grille by pattern name and grille lites wide by grille lites high for each sash. Example shown is “colonial pattern, 2 lites wide by 4 lites tall”.



FARMHOUSE

Default pattern consists of two evenly spaced vertical bars (3/4”) over a 1” wide center bar to simulate a double-hung window. Number of lites wide can be specified to more or less than 3 standard lites.



PRAIRIE

Refer to prairie grille by pattern name for each sash. Regardless of sash size, all prairie grilles intersect to form 4 inch squares of visible glass in the corners of the sash.

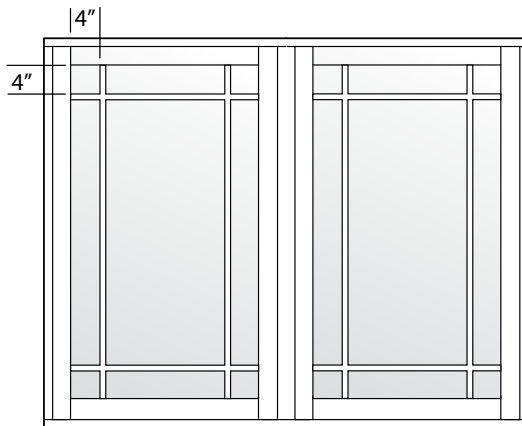

The prairie grille pattern is not available on the following windows:

	Narrower than	Shorter than
Casement	20-5/8"	20-5/8"
Casement-Double	40-1/4"	20-5/8"
Casement Triple (1:1:1)	59-15/16"	20-5/8"
Casement Triple (1:2:1)	78-5/16"	20-5/8"

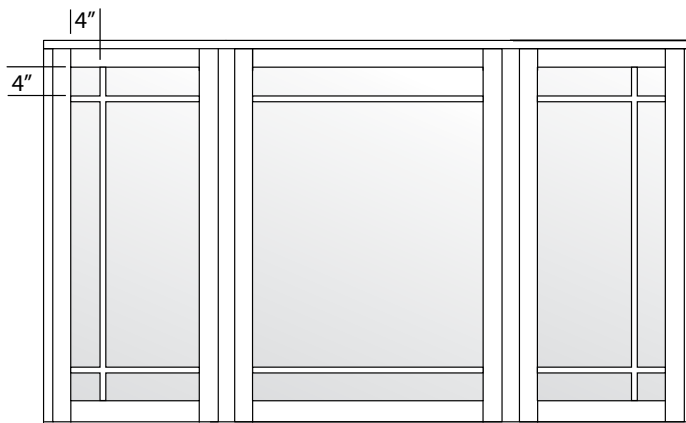

MODIFIED PRAIRIE

Refer to modified prairie grille by pattern name for each sash. Regardless of sash size, all modified prairie grilles intersect to form 4 inch squares of visible glass in the outermost 4 corners of the window, rather than the sash.

Modified prairie grilles are not available on single casement, awning, and standard picture windows.

WINDOW COMPONENT COLOR COMBINATION CHART

CASEMENT WINDOW

	Window Color		Frame and Hardware		GBG		Grilles Full Divided Light	Interior Wood or Full Divided Light	
	Exterior	Interior	Insect Screen Frame	Hardware	Exterior	Interior	Exterior Facing	Interior Facing	
	Single Color	White Canvas Sandtone Terratone	White Canvas Sandtone Terratone	White Canvas Stone Stone	White Canvas Stone Terratone	White Canvas Sandtone Terratone	White Canvas Sandtone Terratone	White Canvas Sandtone Terratone	White Canvas Sandtone Terratone
Dual Color	Exterior	Interior	Insect Screen Frame	Hardware	Exterior	Interior	Exterior Facing	Interior Facing	
	Canvas	White	White	White	Canvas	White	Canvas	White	
	Sandtone	↓	↓	↓	Sandtone	↓	Sandtone	↓	
	Terratone	↓	↓	↓	Terratone	↓	Terratone	↓	
	Cocoa Bean	↓	↓	↓	Cocoa Bean	↓	Cocoa Bean	↓	
	Dark Bronze	↓	↓	↓	Dark Bronze	↓	Dark Bronze	↓	
	Forest Green	↓	↓	↓	Forest Green	↓	Forest Green	↓	
	Black	↓	↓	↓	Black	↓	Black	↓	
	Red Rock	↓	↓	↓	Red Rock	↓	Red Rock	↓	
	White	Canvas	Canvas	Canvas	White	Canvas	White	Canvas	
	Sandtone	↓	↓	↓	Sandtone	↓	Sandtone	↓	
	Terratone	↓	↓	↓	Terratone	↓	Terratone	↓	
	Cocoa Bean	↓	↓	↓	Cocoa Bean	↓	Cocoa Bean	↓	
	Dark Bronze	↓	↓	↓	Dark Bronze	↓	Dark Bronze	↓	
	Forest Green	↓	↓	↓	Forest Green	↓	Forest Green	↓	
Black	↓	↓	↓	Black	↓	Black	↓		
Red Rock	↓	↓	↓	Red Rock	↓	Red Rock	↓		
Stainable Wood Interiors	Exterior	Interior	Low Maintenance Sash	Insect Screen Frame	Hardware	Exterior	Interior	Exterior	Interior
	White	Wood*	Canvas	Stone	Stone	White	Sandtone	White	**Unfinished wood
	Canvas	↓	↓	↓	↓	Canvas	↓	Canvas	↓
	Sandtone	↓	↓	↓	↓	Sandtone	↓	Sandtone	↓
	Terratone	↓	↓	↓	↓	Terratone	↓	Terratone	↓
	Cocoa Bean	↓	↓	↓	↓	Cocoa Bean	↓	Cocoa Bean	↓
	Dark Bronze	↓	↓	↓	↓	Dark Bronze	↓	Dark Bronze	↓
	Forest Green	↓	↓	↓	↓	Forest Green	↓	Forest Green	↓
	Black	↓	↓	↓	↓	Black	↓	Black	↓
	Red Rock	↓	↓	↓	↓	Red Rock	↓	Red Rock	↓

Alternative component and grille color combinations for each frame/sash color are available upon request

* Wood interiors available in: pine, maple and oak

** Pine and maple interiors will use maple species interior grilles. Oak interiors will use oak species interior grilles



Low maintenance sash option clarifications:

1. If window is offered as exterior color only (Example: Forest Green) then this portion of the sash will be canvas.
2. If window is offered as any other color, then interior of the sash will match exterior color of the sash.

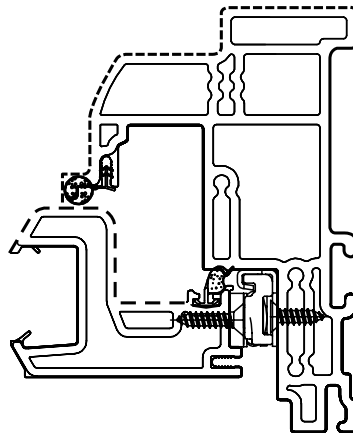

Exterior Color
 Interior Color
 Visible Wood

Fibrex® Material Sash and Frame Exterior/Wood Frame only Interior

WINDOW COLOR/WOOD COMBINATIONS

CASEMENT WINDOW

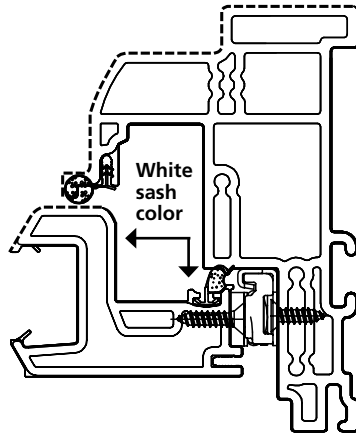

Fibrex® Material Exterior/Wood Interior

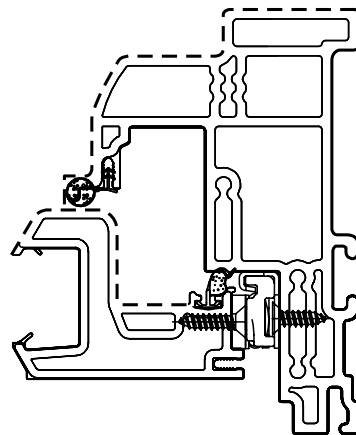

Dual Color

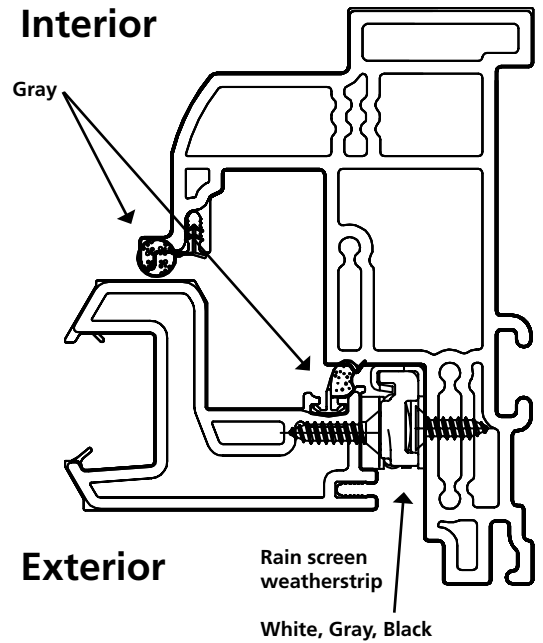

Window Color Exterior	Rain Screen Weatherstrip Color
White or Canvas	White
Sandtone or Terratone	Gray
Cocoa Bean, Dark Bronze, Forest Green, Black or Red Rock	Black

Exterior Color
 Interior Color
 Visible Wood

WINDOW INSTALLATION ACCESSORIES

CASEMENT WINDOW

Frame profile - can be used in either insert or full frame applications. Jamb dimensions is 4" overall.

- Base frame inset provides blind return for certain interior trim or insert applications.
- Extension Jamb Frame (full frame)

Installation Flexibility

Frame can use the following:

- Flange
- Brick mould
 - Traditional
 - Picture frame
- Overfit

Factory mulling within mulling guidelines and restrictions for both frames

- Chamfered Edge Overfit

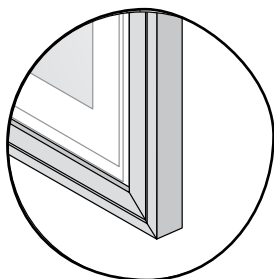
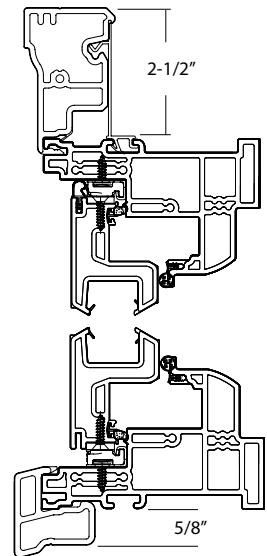
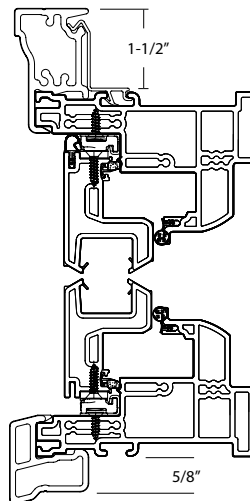
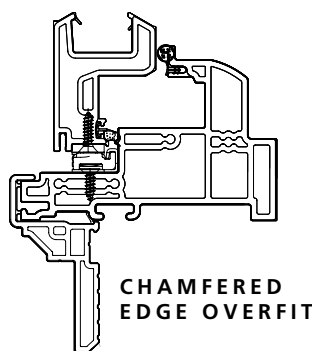
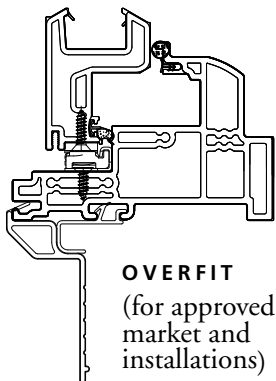
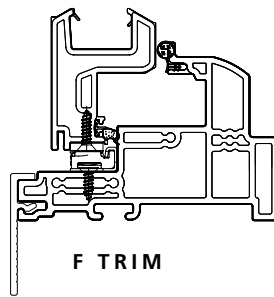
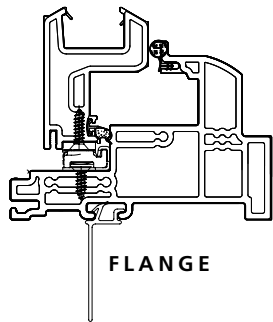
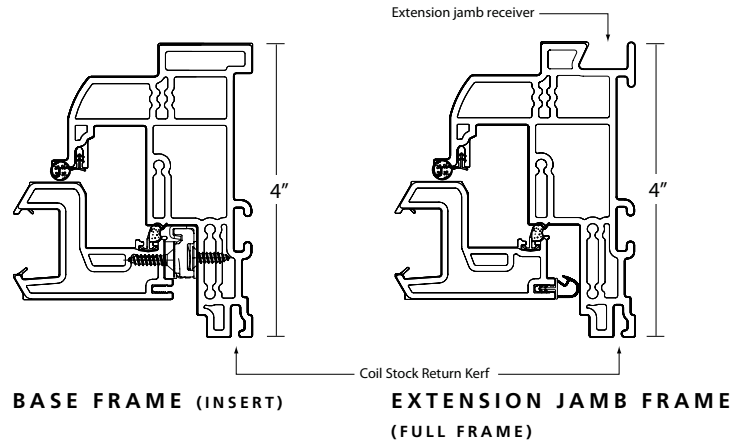

PICTURE FRAME STYLE
(one continuous profile)

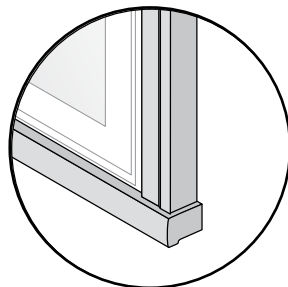

TRADITIONAL STYLE
FULL FRAME BRICK MOULD
(sill nose profile)

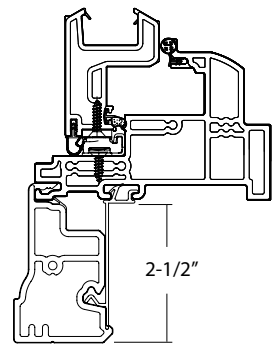
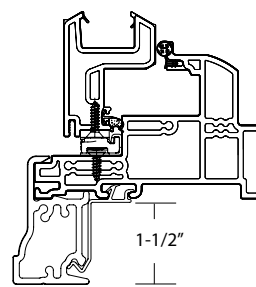

CASEMENT UNIT OFFERINGS

CASEMENT WINDOW

VIEWED FROM EXTERIOR



Single Sash Casement (CS)

Ratio: 1 : 1

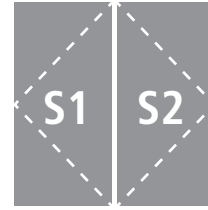

Double Sash Casement, (CD)

- Both sash equal in width (1:1) only
- Sash operable or stationary
- Cannot hinge on center mull post

Ratio: 1 : 1 : 1

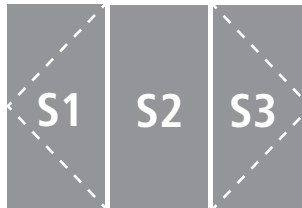

Ratio: 1 : 2 : 1

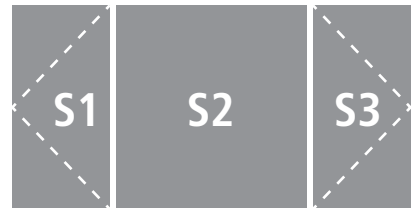

Triple Sash Casement, (CT)

- Sash ratios (1:1:1 or 1:2:1) only
- Sash can be operable or stationary
- Center sash is always fixed
- Side (flankers) can be operable or stationary (cannot hinge on center mull post)

Sash Operation Identification

- Viewed from exterior
- Identify sash operation reading sash from left to right.

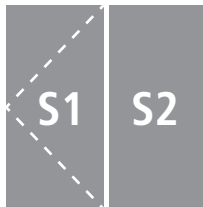

Left Vent/Stationary

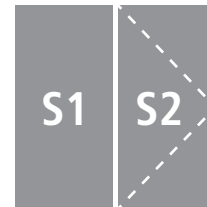

Stationary/Right Vent

See stationary sash casement window (FW) details on page 1-28



Stationary/Stationary/Right Vent

MIN/MAX SIZES

CASEMENT WINDOW (CS)

CaseMENT windows are available in any window dimension between the limits shown here, rounded to the nearest 1/16".

CaseMENT Window Size Limitations			
	Minimum	Minimum with Wide Open Hinge	Maximum
Width	16" *	23 - 1/2" **	40"
Height	17"	17"	80"

United Inch Limitation: 112
Find the United Inches by adding the height and the width (H + W = UI).

Note: CaseMENT windows may be ordered up to a height of 80" as long as the united inches do not exceed 112.

Important: Windows less than 18" wide require wide-open-hinges. Interior washability is not possible with wide-open hinges.

- * To achieve a 20" clear opening with standard hinges, the unit width must be at least 31-3/8" .
- ** To achieve a 20" clear opening with wide-open hinges, the unit width must be at least 27" .

CaseMENT single products perform to PG40. For other CaseMENT products (CD and CT), refer to charts on pages 1-18 and 1-22.

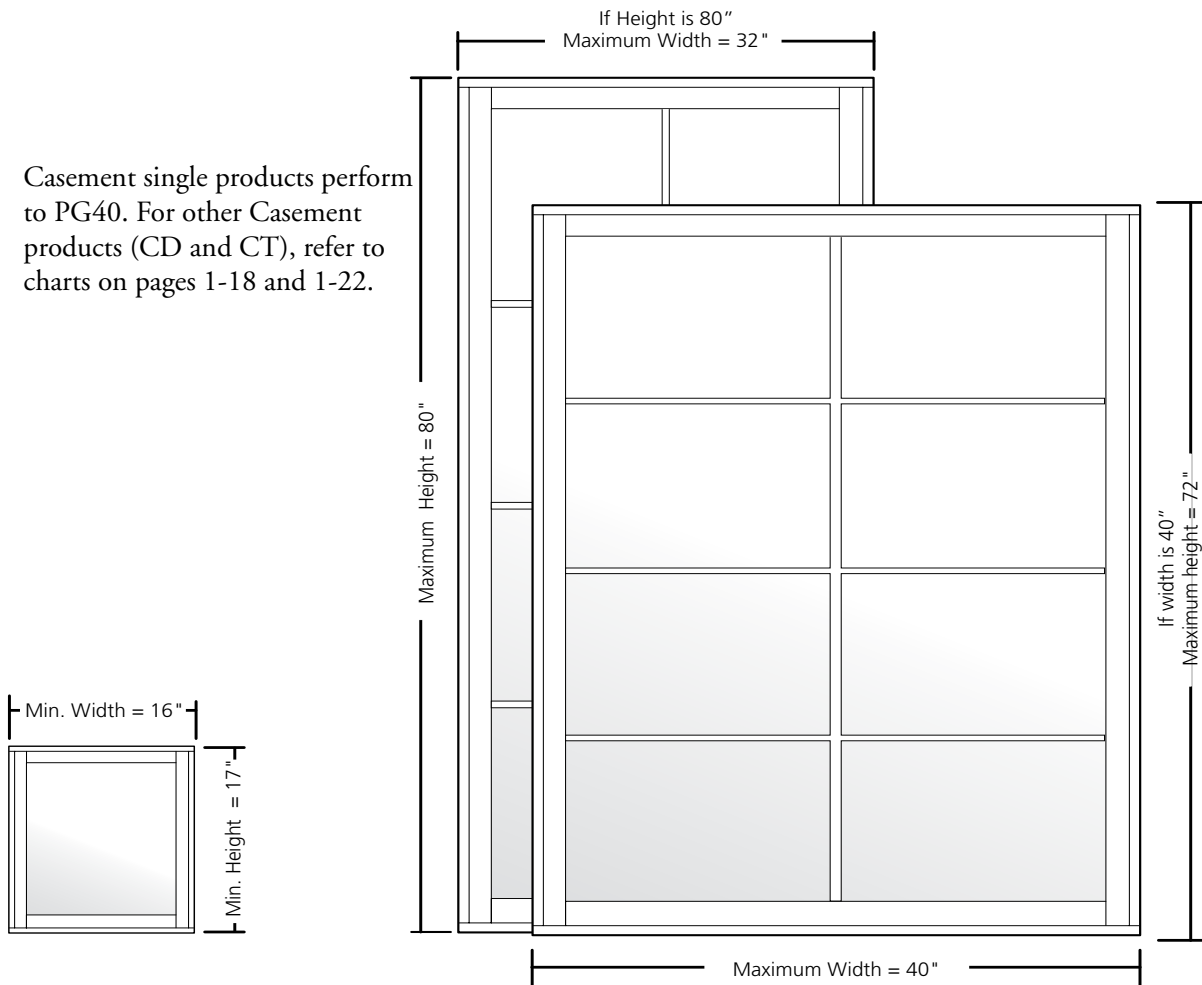

CLEAR OPENING, CLEAR GLASS, AND VENT OPENING DIMENSIONS

CASEMENT SINGLE WINDOW (CS)

Enter unit height (H) and unit width (W) in inches into the formulas below to calculate **Clear Opening** dimensions:

Determining Clear Opening Dimensions (to assess egress code compliance)	
CLEAR OPENING WIDTH (inches)	Standard Hinge Fully-Opened = Width - 11.375 Wide-Open Hinge Fully-Opened = Width - 7.000
CLEAR OPENING HEIGHT (inches)	= H - 5.500
CLEAR OPENING AREA (ft²)	= $\frac{(\text{Clear Opening Width}) \times (\text{Clear Opening Height})}{144}$

Enter unit height (H) and unit width (W) in inches into the formulas below to calculate **Clear Glass** or **Vent Opening** square footage dimensions:

Determining Clear Glass and Vent Opening Dimensions	
CLEAR GLASS AREA (ft²)	= $\frac{(W - 6.500) \times (H - 6.500)}{144}$
VENT OPENING AREA (ft²)	= $\frac{(W - 5.500) \times (H - 5.500)}{144}$



To achieve a 20" clear opening with wide- open-hinges, the unit width must be at least 27".

Clear Opening Width formulas are used to determine **"Egress Opening"** Dimensions.

For most areas, **egress opening codes** dictate minimum width, height, and total area. Check with your local code officials to determine the precise egress codes for each home.

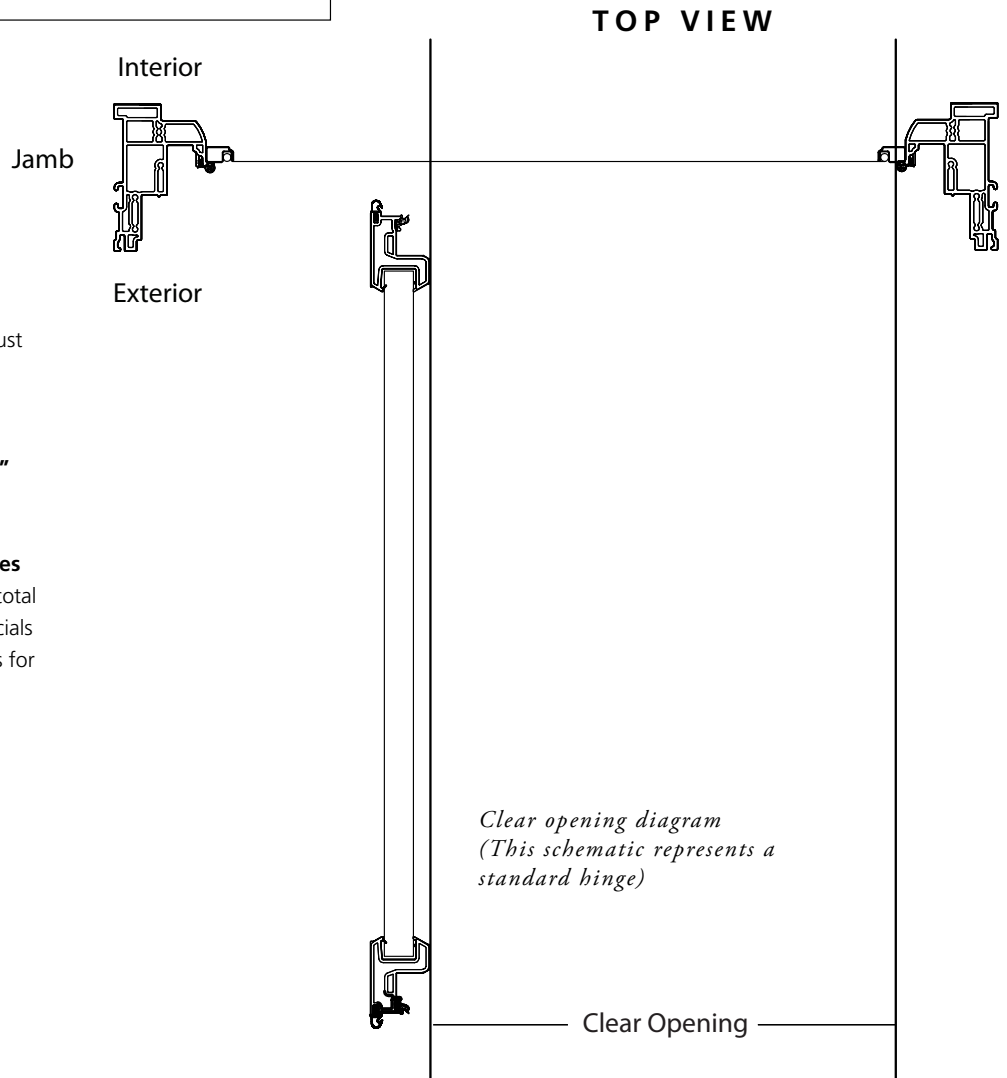

*Clear opening diagram
(This schematic represents a standard hinge)*

WIDE-OPEN-HINGE

CASEMENT SINGLE WINDOW (CS)

Wide-Open-Hinge is standard.

Washability of exterior side of window from interior of home will be limited.

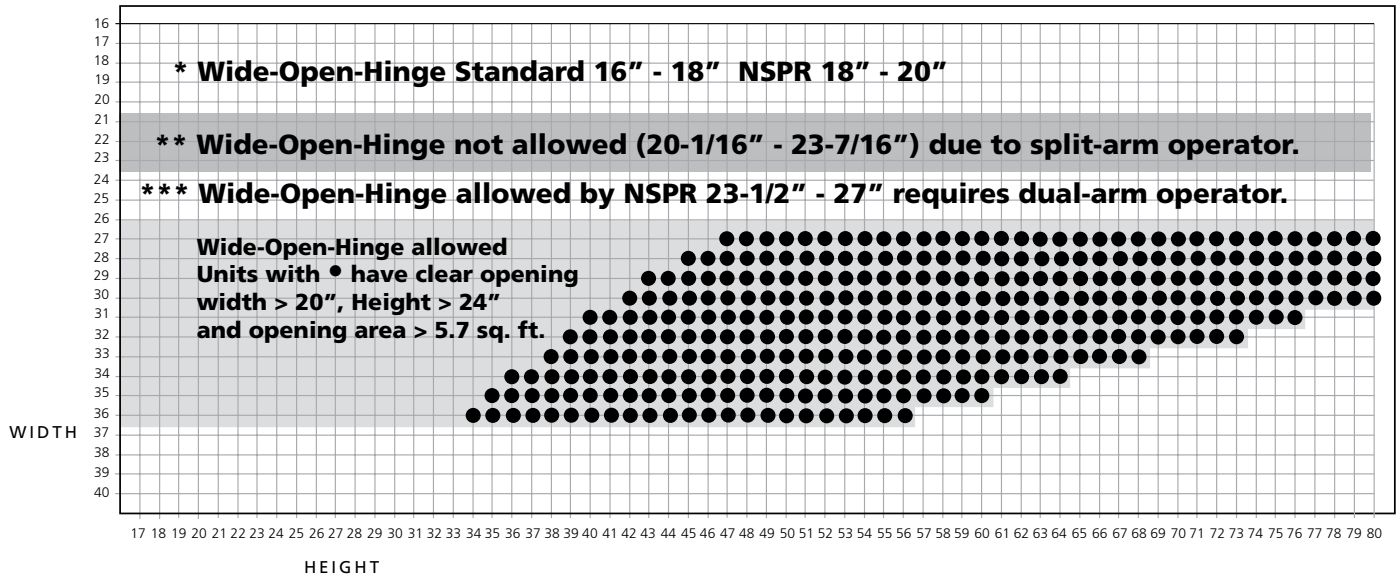
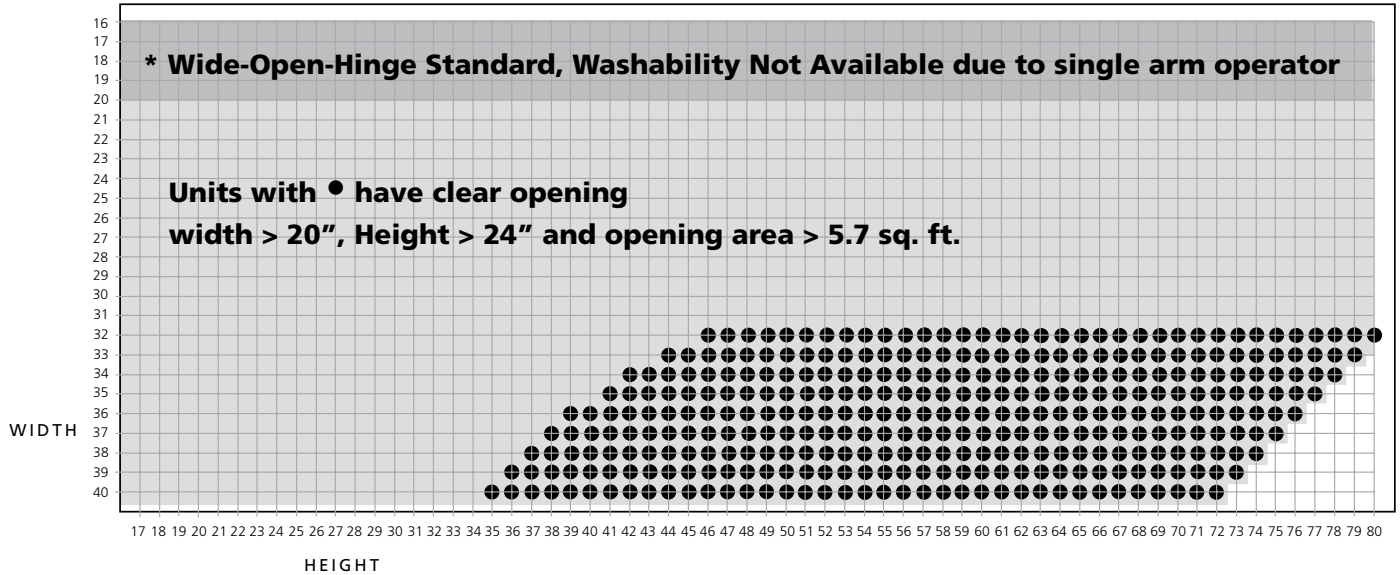

WINDOW OPENING AND DIMENSIONAL SPECIFICATIONS

CASEMENT SINGLE WINDOW (CS)



Window profiles shown for measurement purposes.



All dimensions shown are approximate. For precise clear opening and clear glass dimensions, refer to the Clear Opening, Clear Glass, and Vent Opening Dimensions charts on the 1-15.

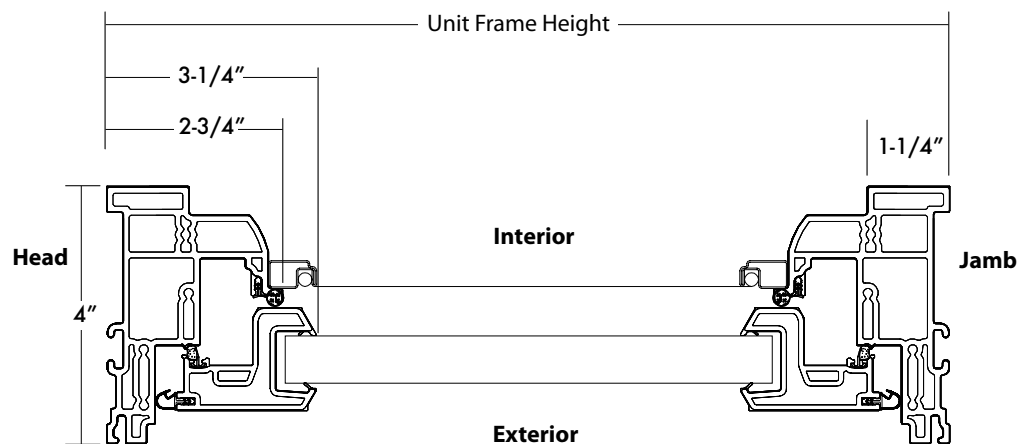
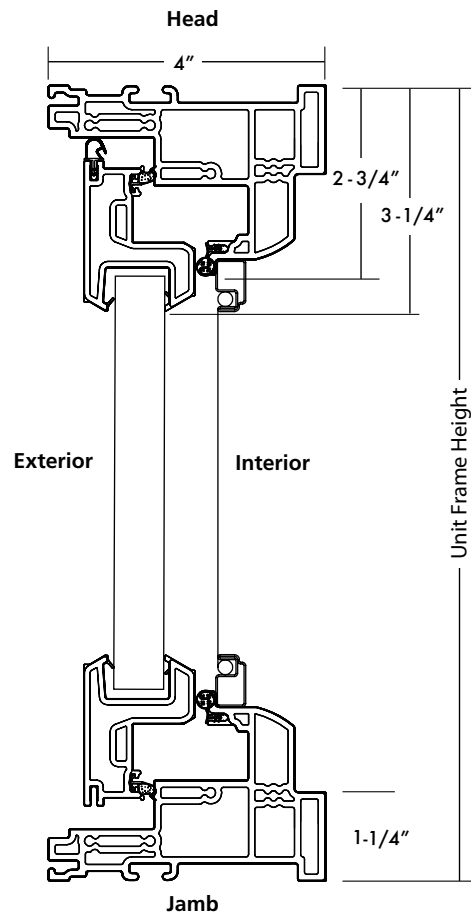

MIN/MAX SIZES

CASEMENT DOUBLE WINDOW (CD)

CaseMENT double windows are available in any window dimension between the limits shown here, rounded to the nearest 1/16".

CaseMENT Double Window Size Limitations

	Minimum	Minimum with wide-open hinges	Maximum
Width	31-1/8" *	43-1/16" **	79"
Height	17"	17"	80"

United Inch Limitation: 142

Find the United inches by adding the height and the width (H + W = UI).

Note: Casement double windows may be ordered up to a height of 80" as long as the United Inches do not exceed 142".

Important: Windows less than 35-1/8" require wide-open hinges. Interior washability is not possible with wide-open hinges.

* To achieve a 20" clear opening with standard hinges, the unit width must be at least 61 7/8".

** To achieve a 20" clear opening with wide-open hinges, the unit width must be at least 53 1/8".



1 : 1 ratio only.

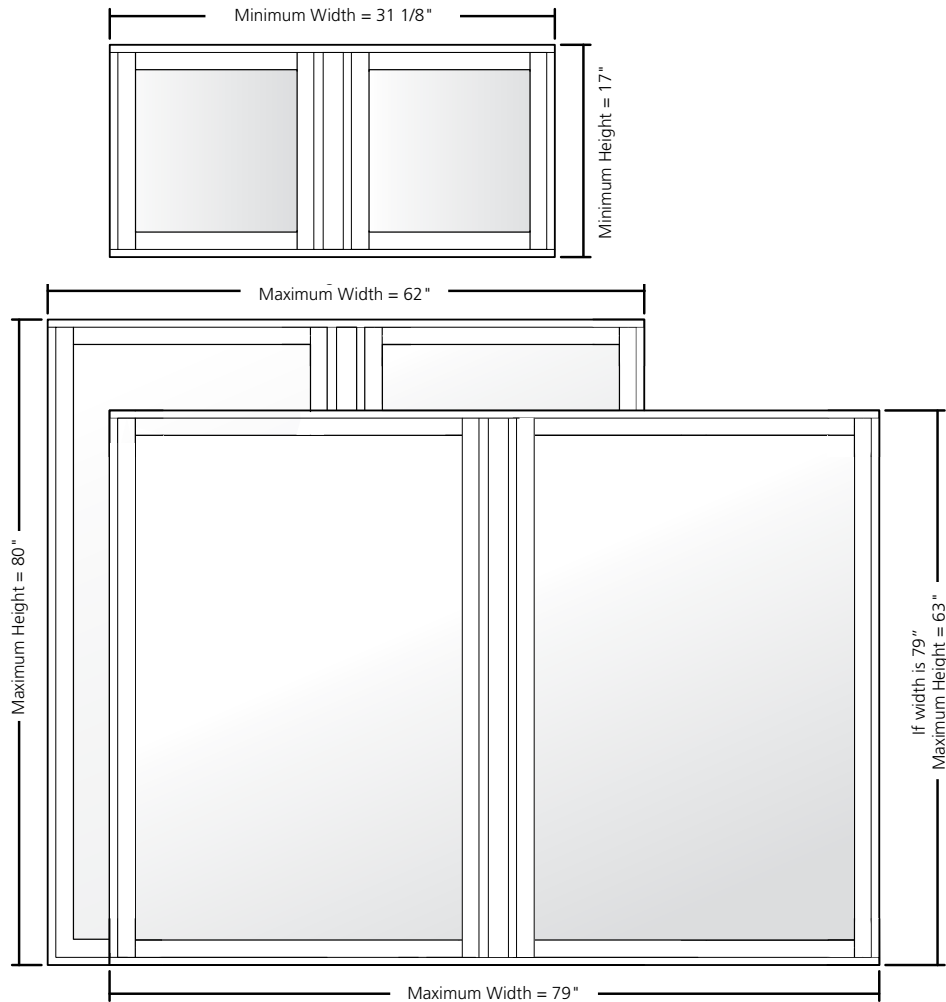

RELATIVE PERFORMANCE

CASEMENT DOUBLE WINDOW (CD)



Any casement windows in extended maximum height range must have 2 locks.



The PG numbers in this chart represent **overall window performance ratings**. (The lowest number for air and water tightness and wind load resistance performance data is shown here.)

Performance ratings change for casement windows over 72" wide or over 60" high.

Refer to Technical Data section of this manual for complete product performance information.

Casement Double - Performance Table

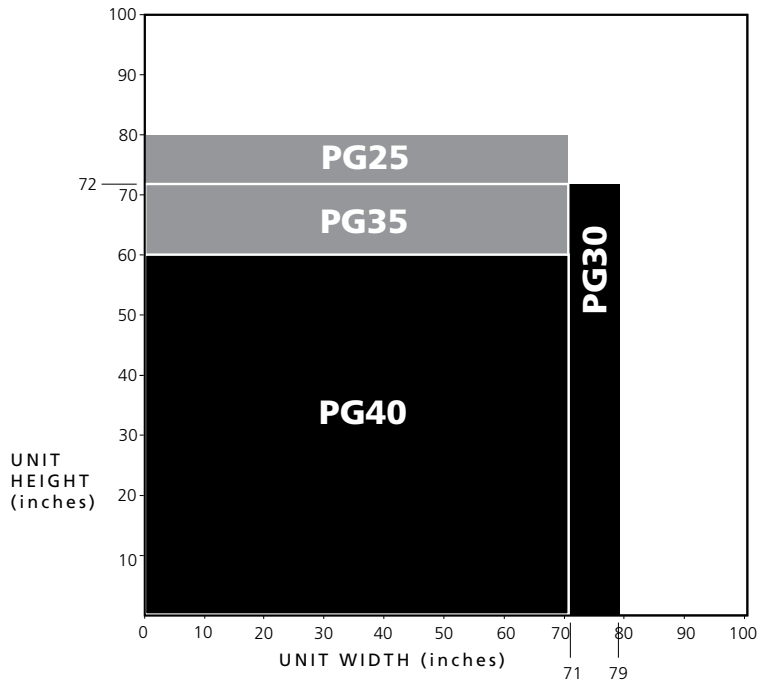

CLEAR OPENING, CLEAR GLASS, AND VENT OPENING DIMENSIONS

CASEMENT DOUBLE WINDOW (CD)

Enter unit height (H) and unit width (W) in inches into the formulas below to calculate **Clear Opening** dimensions:

Enter unit height (H) and unit width (W) in inches into the formulas below to calculate **Clear Glass, Overall Unit Area** or **Vent Opening** square footage dimensions:

Determining Clear Opening Dimensions (to assess egress code compliance)	
CLEAR OPENING WIDTH (inches)	Standard Hinge Fully Opened = $W/2 - 10.850$
	Wide-Open Hinge Fully Opened = $W/2 - 6.534$
CLEAR OPENING HEIGHT (inches)	= $H - 5.500$
CLEAR OPENING AREA per sash (ft ²)	= $\frac{(\text{Clear Opening Width}) \times (\text{Clear Opening Height})}{144}$

Determining Total Glass, Overall Unit, and Vent Opening Dimensions	
TOTAL GLASS AREA (ft ²) of BOTH SASH COMBINED	= $\frac{(W - 12.000) \times (H - 6.500)}{144}$
VENT OPENING AREA (ft ²) of BOTH SASH COMBINED	= $\left[\frac{(W - 10.000) \times (H - 5.500)}{144} \right] \times 2$

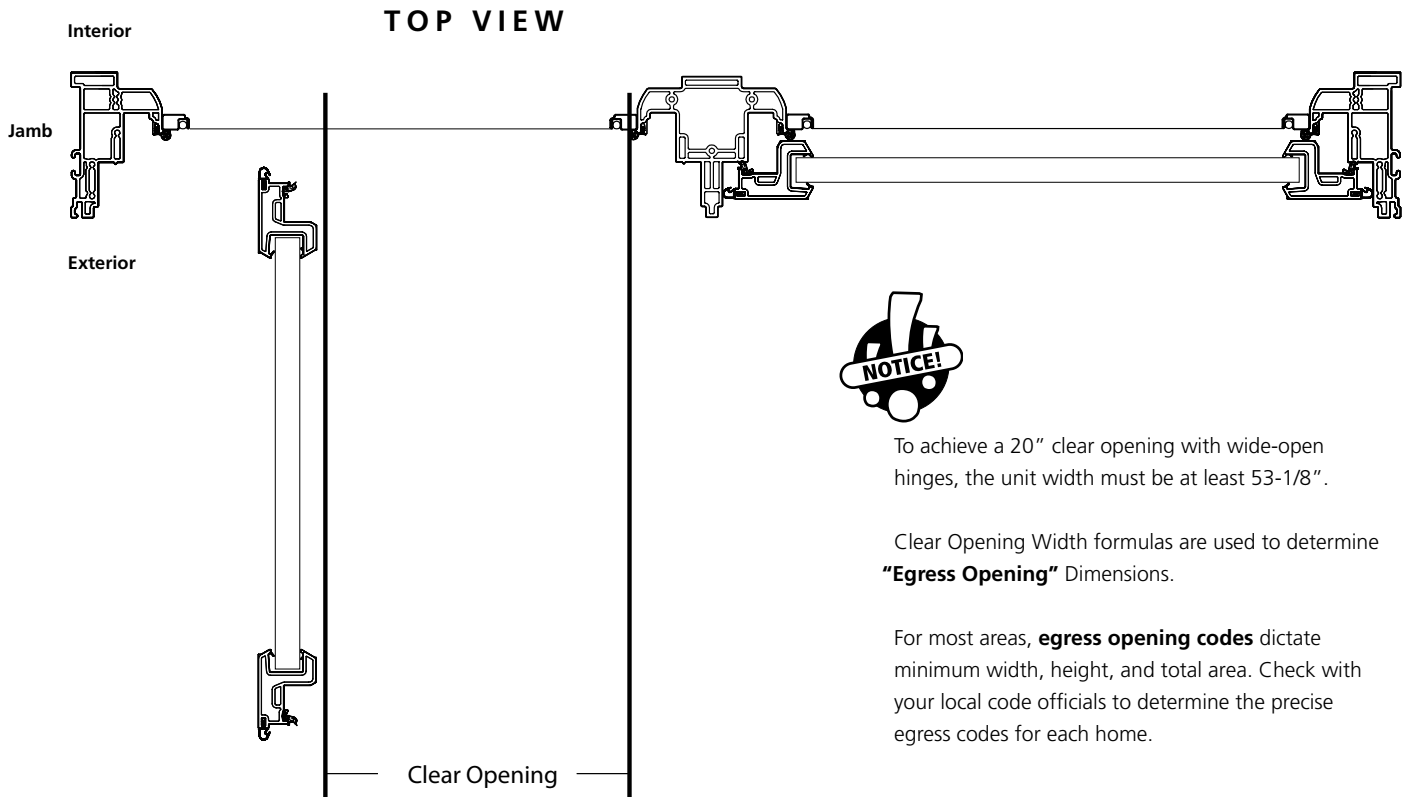

*Clear opening diagram
(This schematic represents a standard hinge)*



To achieve a 20" clear opening with wide-open hinges, the unit width must be at least 53-1/8".

Clear Opening Width formulas are used to determine "Egress Opening" Dimensions.

For most areas, **egress opening codes** dictate minimum width, height, and total area. Check with your local code officials to determine the precise egress codes for each home.

WINDOW OPENING AND DIMENSIONAL SPECIFICATIONS

CASEMENT DOUBLE WINDOW (CD)



Window profiles shown for measurement purposes.



All dimensions shown are approximate. For precise clear opening and clear glass dimensions, refer to the Clear Opening, Clear Glass, and Vent Opening Dimensions charts on the previous page.

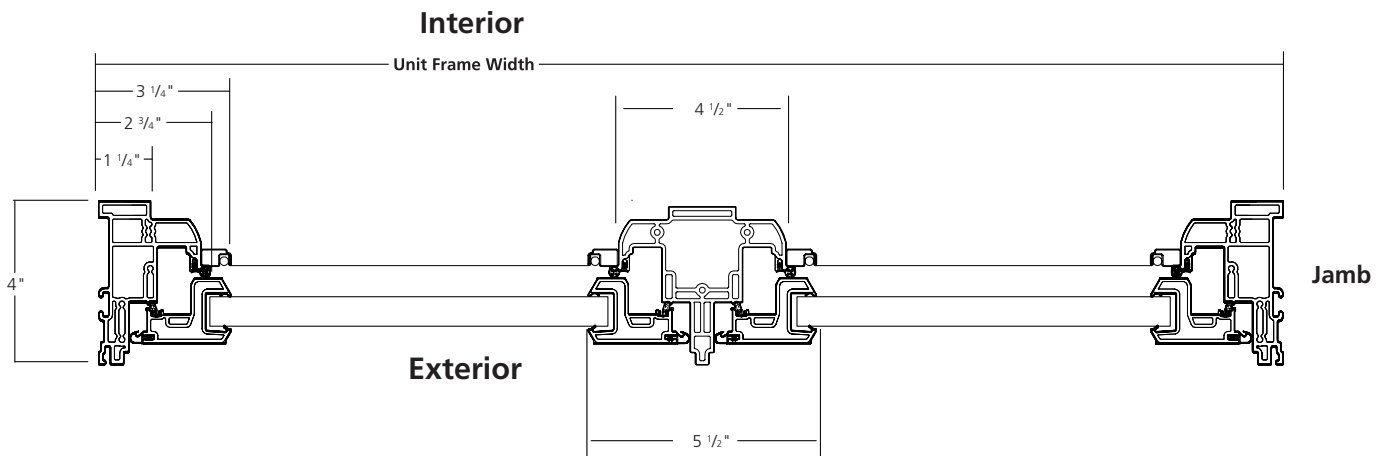
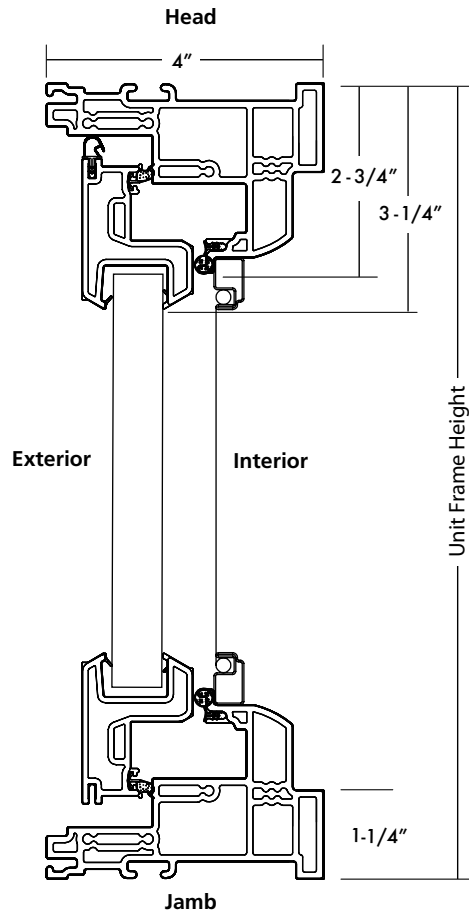

MIN/MAX SIZES

CASEMENT TRIPLE WINDOW (CT)

Casement triple windows are available in any window dimension between the limits shown here, rounded to the nearest 1/16".

Casement Triple Window Size Limitations				
		Minimum	Minimum with Wide-Open Hinge	Maximum
1:1:1 Sash Ratio	Width	46-3/16" *	68-5/8" ***	118"
	Height	17"	17"	80"
1:2:1 Sash Ratio	Width	60-1/16"	90" ***	120"
	Height	17"	17"	80"

United Inch Limitation: 190 for 1:1:1 and 1:2:1 units.
Find the United Inches by adding the height and the width (H + W = UI).

Note: Casement triple windows may be ordered up to a height of 80" as long as the maximum width does not exceed 105" (1:1:1) or 105" (1:2:1). Casement Triple height reduced to 72" if width is greater than 105" (1:1:1) or 105" (1:2:1).

Important: CT (1:1:1) windows less than 52-3/16" require wide-open-hinges and CT (1:2:1) windows less than 68" defaults to wide-open hinges. Interior washability is not possible with wide-open-hinges.

* To achieve a 20" clear opening with standard hinges, the unit width must be at least 92-5/16".

** To achieve a 20" clear opening with wide-open-hinges, the unit width must be at least 68-5/8" .

*** To achieve a 20" clear opening with wide-open-hinges, the unit width must be at least 90" .

Casement windows are available with three openings that incorporate combinations of operating sash and stationary sash in a single frame. All measuring and installation procedures remain the same as the single opening style.

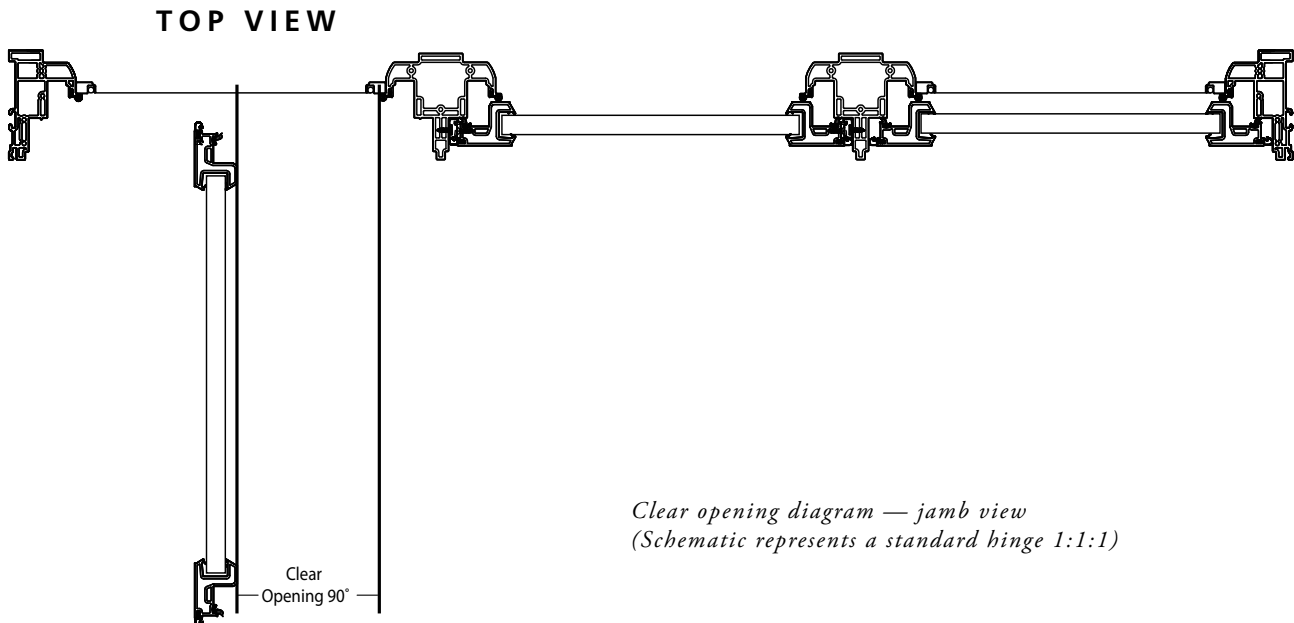

RELATIVE PERFORMANCE

CASEMENT TRIPLE WINDOW (CT 1:1:1)

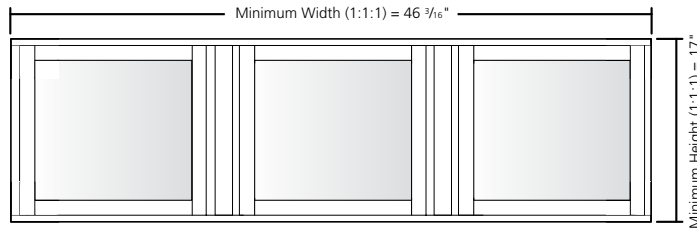

Any casement windows in extended maximum height range must have 2 locks.



The PG numbers in this chart represent **overall window performance ratings**. (The lowest number for air and water tightness and wind load resistance performance data is shown here.)

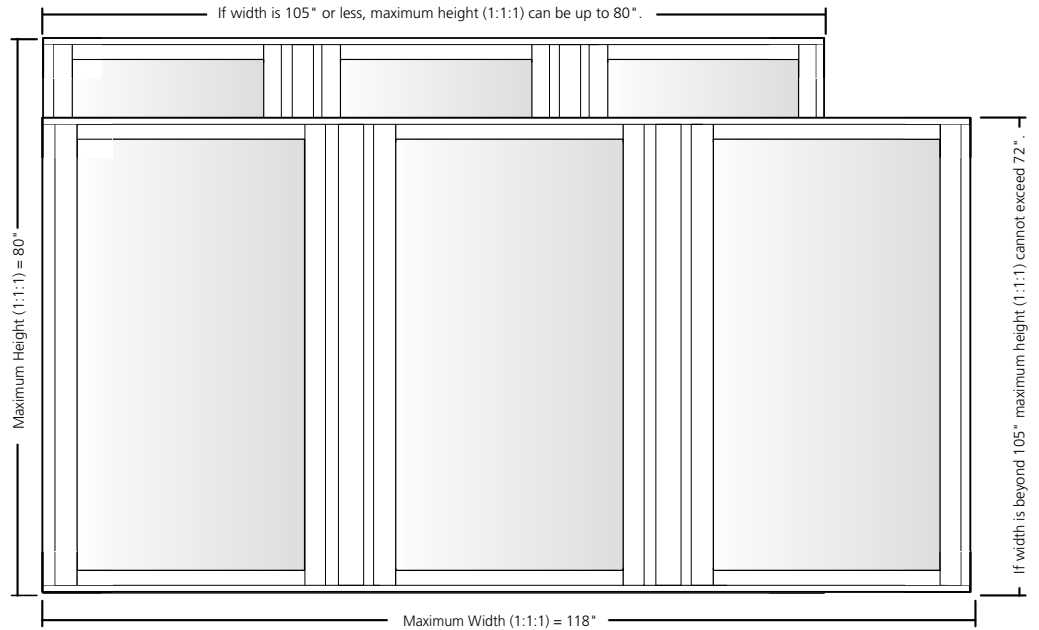

Casement Triple 1 : 1 : 1 - Performance Table

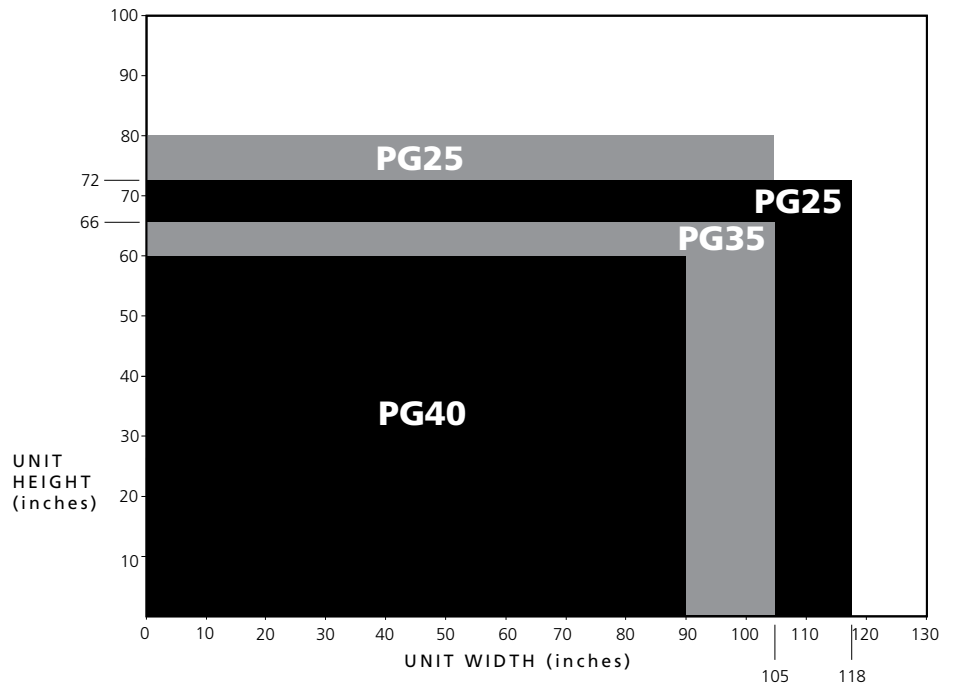

RELATIVE PERFORMANCE

CASEMENT-TRIPLE WINDOW (CT 1:2:1)

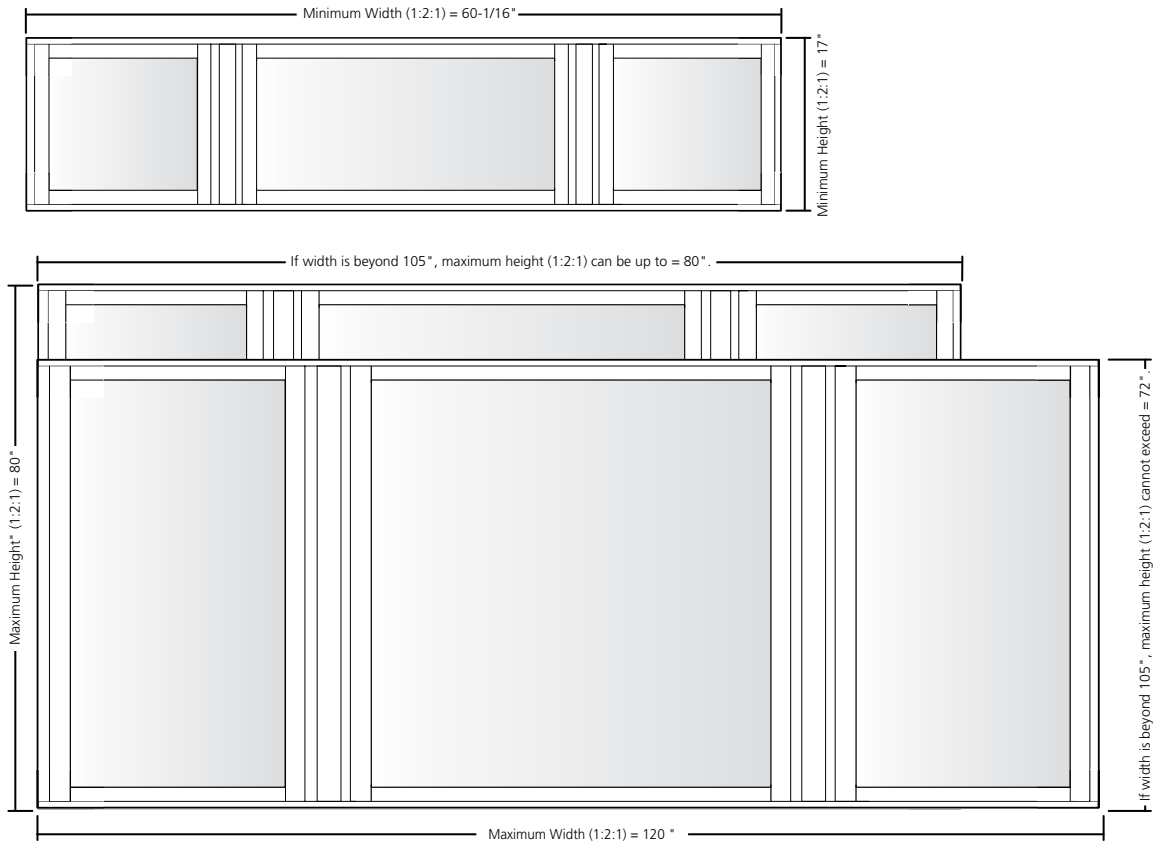

Any casement windows in extended maximum height range must have 2 locks.



The PG numbers in this chart represent **overall window performance ratings**. (The lowest number for air and water tightness and wind load resistance performance data is shown here.)

Performance ratings change for casement windows over 90" wide or over 60" high.

Refer to Technical Data section of this manual for complete product performance information.

Casement Triple 1 : 2 : 1 - Performance Table

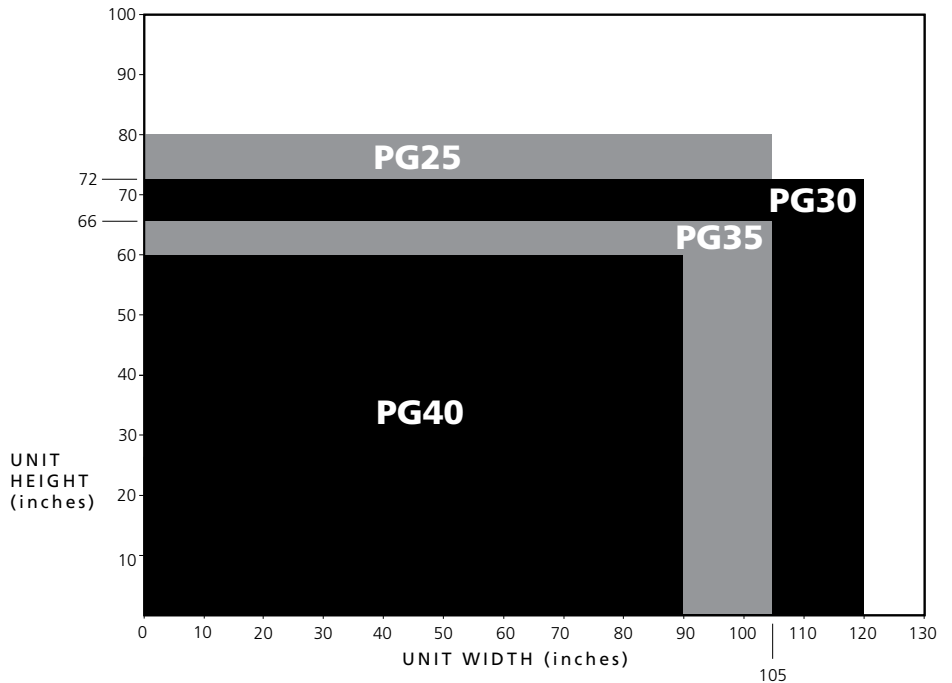

CLEAR OPENING, CLEAR GLASS, AND VENT OPENING DIMENSIONS

CASEMENT TRIPLE WINDOW (CT)

Enter unit height (H) and unit width (W) in inches into the formulas below to calculate **Clear Opening** dimensions:

Determining Clear Opening Dimensions (to assess egress code compliance)	
CLEAR OPENING WIDTH (inches)	1:1:1 Standard Hinge Fully opened = $W / 3 - 10.700$ Wide-Open Hinge Fully opened = $W / 3 - 7.600$
	1:2:1 Standard Hinge Fully opened = $W / 4 - 12.470$ Wide-Open Hinge Fully opened = $W / 4 - 8.154$
	CLEAR OPENING HEIGHT (inches) = $H - 5.500$
	CLEAR OPENING AREA PER SASH (ft ²) = $\frac{(\text{Clear Opening Width}) \times (\text{Clear Opening Height})}{144}$

Enter unit height (H) and unit width (W) in inches into the formulas below to calculate **Clear Glass, Overall Unit, or Vent Opening** square footage.

Determining Clear Glass and Vent Opening Dimensions	
TOTAL GLASS AREA OF ALL 3 SASH (1:1:1 and 1:2:1) (ft ²)	= $\frac{(W - 17.670) \times (H - 6.500)}{144}$
VENT OPENING AREA (ft ²) OF BOTH SASH	1:1:1 = $\left[\frac{(W - 4.650 + 1.703)}{3} \times \frac{(H - 5.500)}{144} \right] \times 2$ 1:2:1 = $\left[\frac{(W - 4.650 + 1.703)}{4} \times \frac{(H - 5.500)}{144} \right] \times 2$
MULL POST LOCATION	1:1:1 = $\left[\frac{(W - 4.650 + 1.703)}{3} \right]$ 1:2:1 = $\left[\frac{(W - 4.650 + 1.703)}{4} \right]$



To achieve a 20" clear opening with wide-open hinges, the unit width must be at least 79-3/16" for CT 1:1:1 sash ratio, and at least 104" for CT 1:2:1 sash ratio.

Clear Opening Widths formulas are used to determine **"Egress Opening"** Dimensions.

For most areas, **egress opening codes** dictate minimum width, height, and total area. Check with your local code officials to determine the precise egress codes for each home.

CUSTOM MULL POST CAPABILITY

CASEMENT TRIPLE WINDOW (CT)

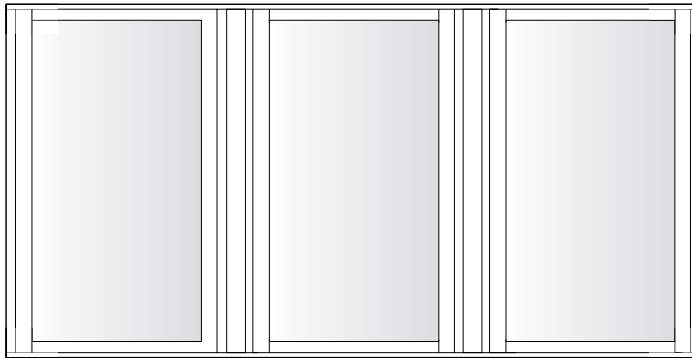

2 As viewed from exterior

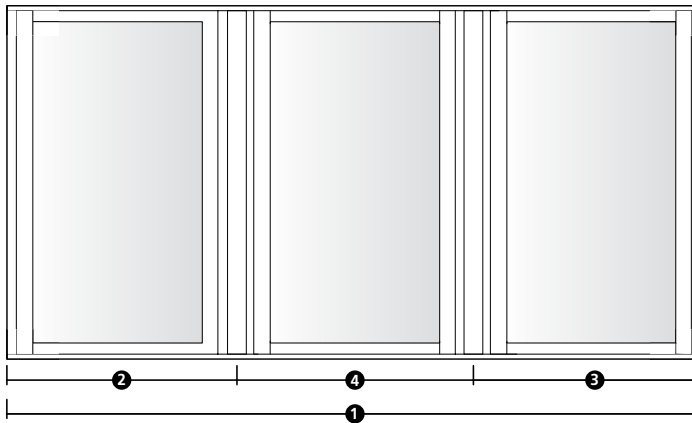

Custom Mull Post Capability

In addition to the two predetermined Casement Triple (CT) sash ratios (1:1:1 and 1:2:1), custom mull post location is possible through submitting a Non-Standard Product Request (NSPR). General parameters for this are based on the following:

- 1 Post location based (indexed) from edge of left-hand side jamb to center of post, as viewed from exterior.
- 2 Minimum width (to center line of post) 15-9/16".
- 3 Maximum width (to center line of post) 39-1/2".
- 4 Minimum center post line to achieve 20" clear opening with wide open hinge 26-9/16"
- 5 Normally, center post location will be symmetrical. Asymmetrical post location possibility is limited. Contact your Customer Service Representative (CSR) for details.
- 6 Dimension 1 minus 2 minus 3 = 4 must be greater than 15"
- 7 Dimension 1 minus 2 minus 3 = 4 must be less than 59".

WINDOW OPENING AND DIMENSIONAL SPECIFICATIONS

CASEMENT TRIPLE WINDOW (CT)



Window profiles shown for measurement purposes.

All dimensions shown are approximate. For precise clear opening and clear glass dimensions, refer to the Clear Opening, Clear Glass, and Vent Opening Dimensions charts on the previous page.

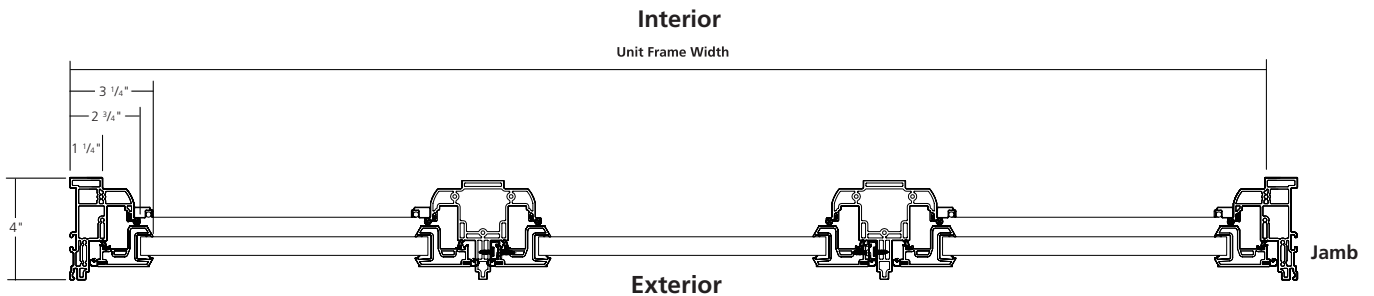
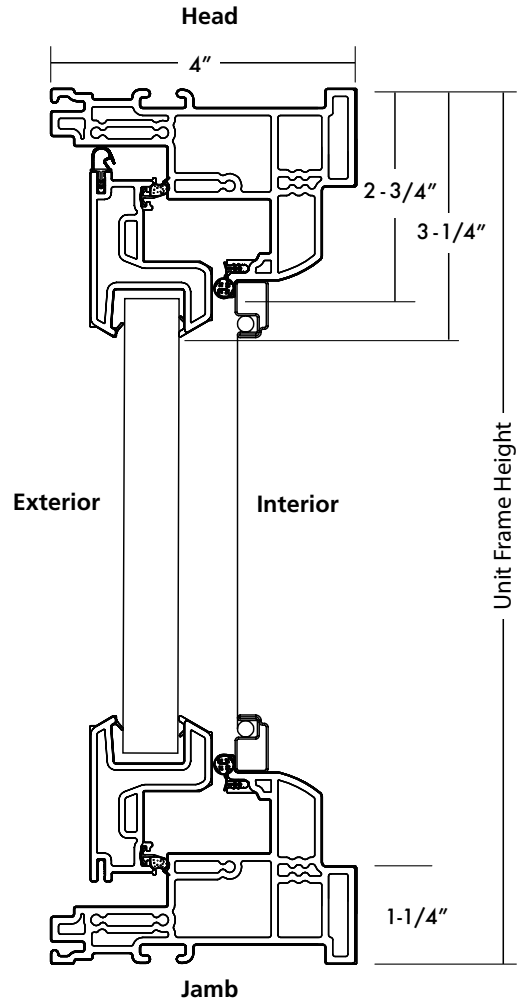

FIXED WINDOW (FW)

ADVANTAGES AND APPLICATIONS

The fixed window consists of a fixed lite of glass in a frame. The sash profile complements the Renewal by Andersen® casement and awning windows.



*Fixed
Casement/Awning
Windows*

ADVANTAGES

- Full-perimeter silicone bed glazing provides a strong seal between glass and sash.
- Patented Fibrex® material is stronger than vinyl, allowing more glass area to show.
- Fibrex material with low-maintenance capstock gives a rich, low-luster finish to sash and frame, similar to painted wood.
- Smooth radius surfaces on frame and sash are pleasing to the eye and easier to clean.

APPLICATIONS

- Fixed windows are the first choice when large viewing areas and daylight are desired and ventilation is not required.
- Effective in very large openings that cannot be filled with other styles of windows.
- Used extensively as stationary windows next to vent casement and awning windows.
- Visually compatible with casement & awning Renewal by Andersen products.

MIN/MAX SIZES

FIXED WINDOW (FW)

Fixed windows are available in any window dimension between the limits shown here, rounded to the nearest 1/16".



One dimension, either width or height, cannot exceed 60".

Fixed Window Size Limitations		
	Minimum	Maximum
Width	16"	60" or 80" *
Height	17"	80" or 60"

United Inch Limitation: 140
Find the United Inches by adding the height and the width (H + W = UI).

* NOTE: For this (80" x 60") configuration, rails run through stiles versus standard (60" x 80") configuration where stiles run through rails.

Casement single products perform to PG40. For other Casement products (CD and CT), refer to charts on pages 1-18 and 1-23.

